

C (1 : 3)

REVISION HISTORY		
REV	DESCRIPTION	DATE
1a		29/03/2018

DESIGNED BY F. Dino	CHECKED AND APPROVED BY L. Paleari	GENERAL TOLLERANCE SS-ISO-2768-1M	DATE 28/03/2018	CODE T601300B
PACKAGING Carton 1 piece			UNIT mm	SHEET 1 of 4
DESCRIPTION RAM INDUSTRIE			MATERIAL Anodise aluminum alloy 6060	
DEVICE			PAIR WEIGHT WITH CARTON 14 Kg	

Property of RAM Industrie.
Without its written authorization the present drawing shall neither be used for construction anyway, communicated to third parties, nor reproduced.

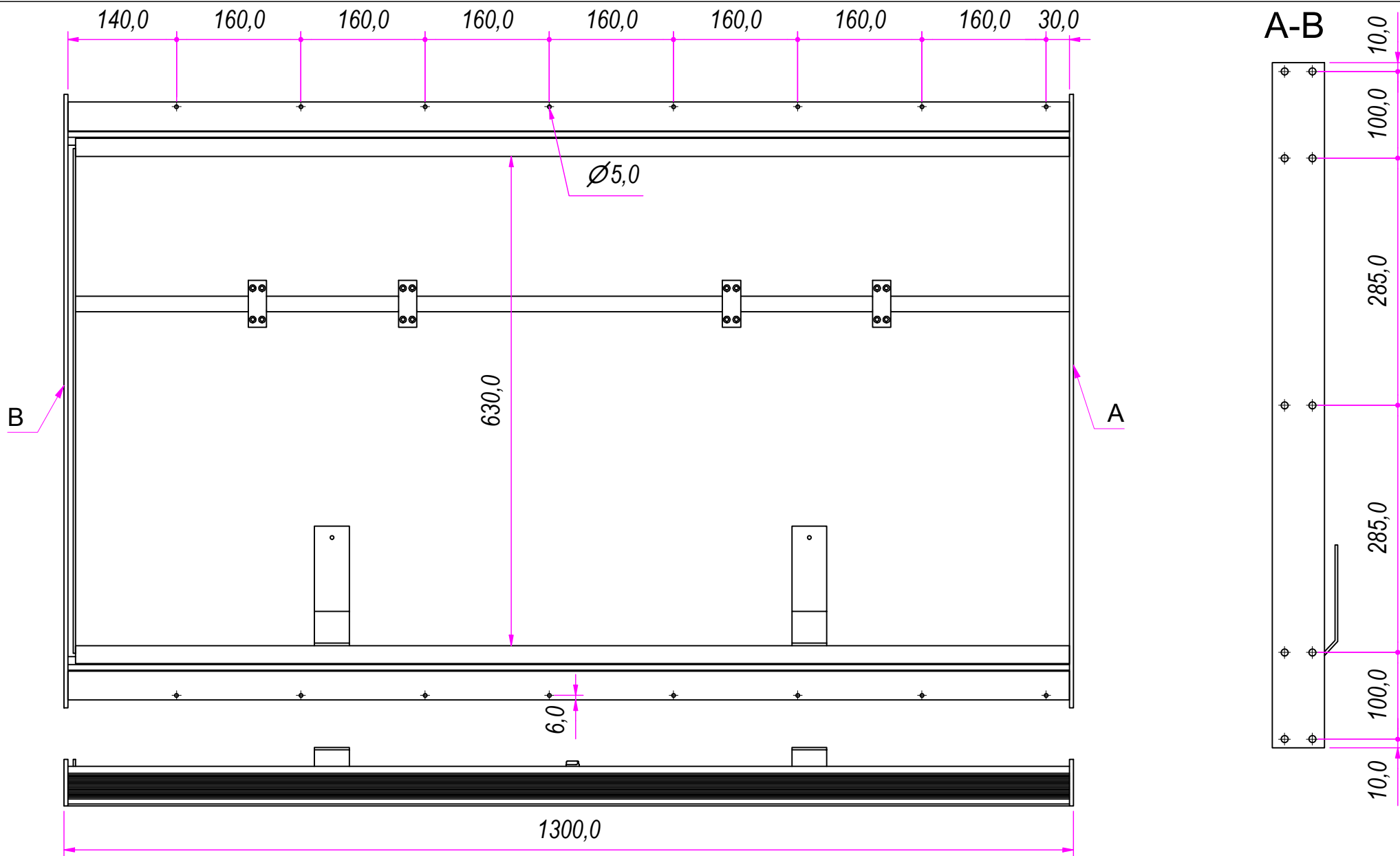

DESIGNED BY F. Dino	CHECKED AND APPROVED BY L. Paleari	GENERAL TOLERANCE SS-ISO-2768-1M	DATE 28/03/2018	CODE T601300B
		PACKAGING Carton 1 piece	UNIT mm	SHEET 2 of 4
		DESCRIPTION	MATERIAL Anodise aluminum alloy 6060	
DEVICE			PAIR WEIGHT WITH CARTON 14 Kg	

REVISION HISTORY		
REV	DESCRIPTION	DATE
1a		29/03/2018

Property of RAM Industrie.
Without its written authorization the present drawing shall neither be used for construction anyway, communicated to third parties, nor reproduced.

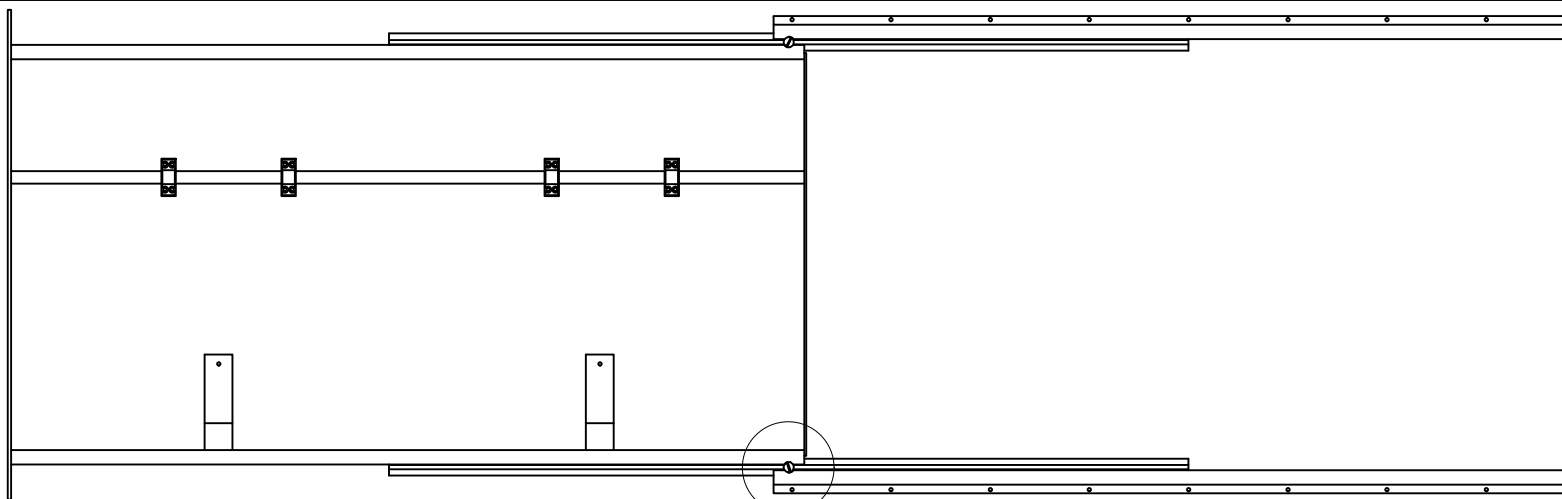

D
2530,0

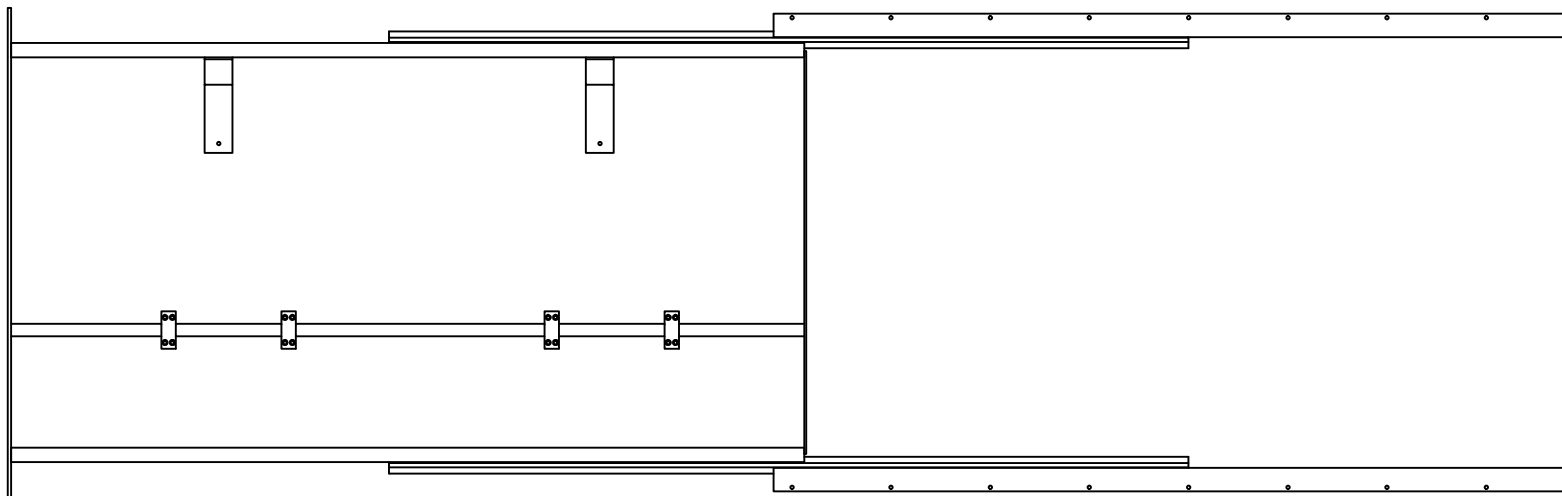
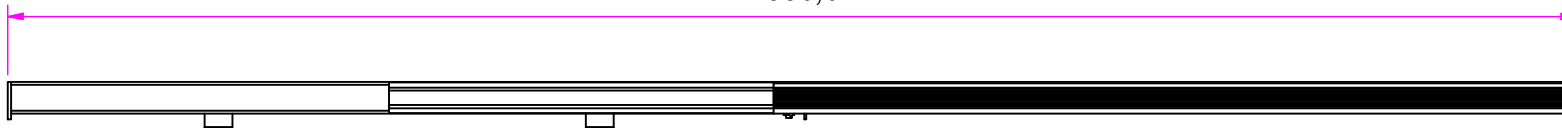

D (1 : 5)

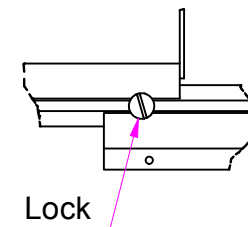



DESIGNED BY F.Dino	CHECKED AND APPROVED BY L. Paleari	GENERAL TOLLERANCE SS-ISO-2768-1M	DATE 28/03/2018	CODE T601300B
PACKAGING Carton 1 piece		UNIT mm	SHEET 3 of 4	
DESCRIPTION		MATERIAL Anodise aluminum alloy 6060		
DEVICE		PAIR WEIGHT WITH CARTON 14 Kg		

RAM
INDUSTRIE

REVISION HISTORY		
REV	DESCRIPTION	DATE
1a		29/03/2018

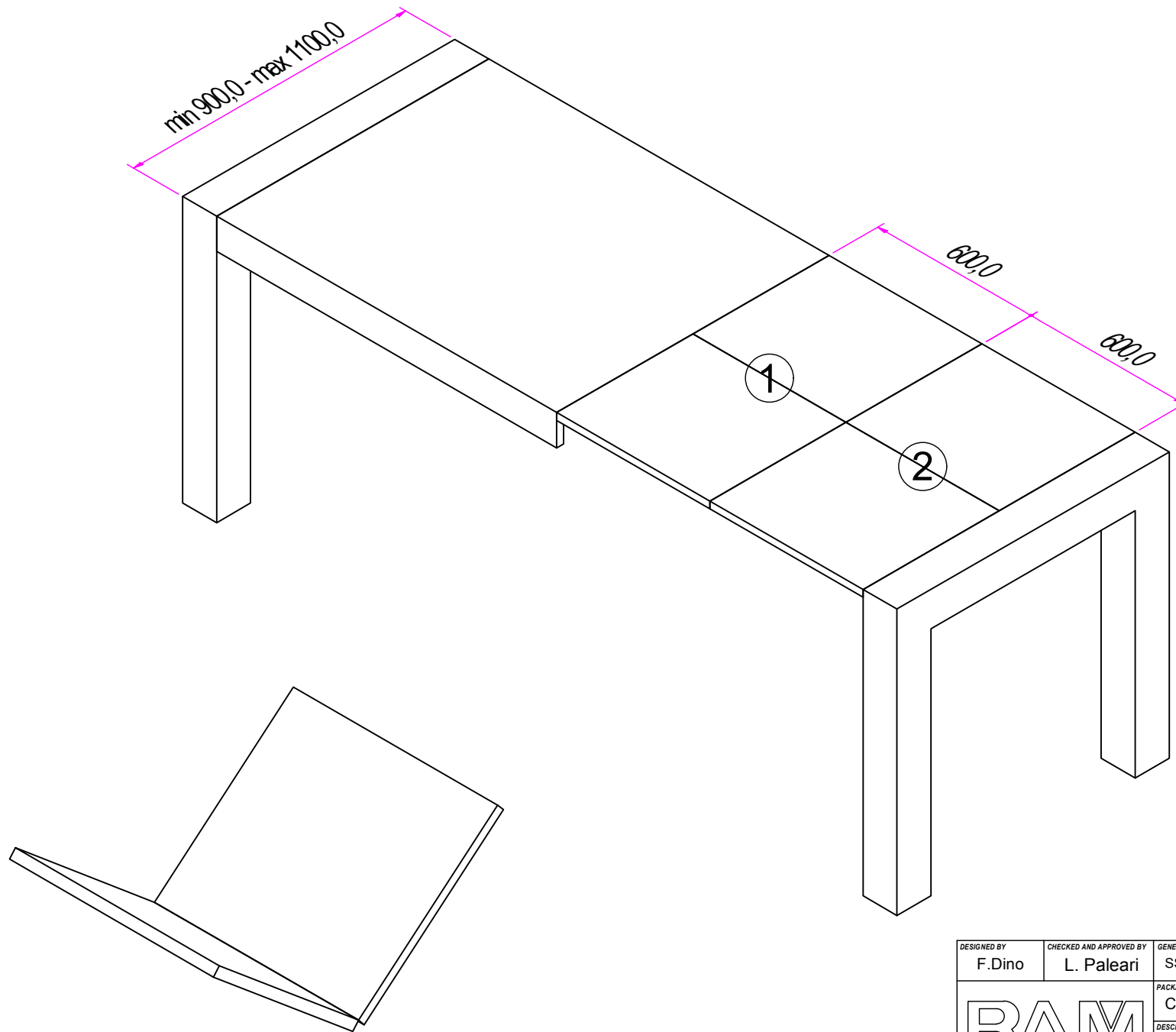
Property of RAM Industrie.
Without its written authorization the present drawing shall neither be used for construction anyway, communicated to third parties, nor reproduced.



DESIGNED BY F.Dino	CHECKED AND APPROVED BY L. Paleari	GENERAL TOLERANCE SS-ISO-2768-1M	DATE 28/03/2018	CODE T601300B
		PACKAGING Carton 1 piece	UNIT mm	SHEET 4 of 4
		DESCRIPTION	MATERIAL Anodise aluminum alloy 6060	
DEVICE			PAIR WEIGHT WITH CARTON 14 Kg	

Property of RAM Industrie.
Without its written authorization the present drawing shall neither be used for construction anyway, communicated to third parties, nor reproduced.