

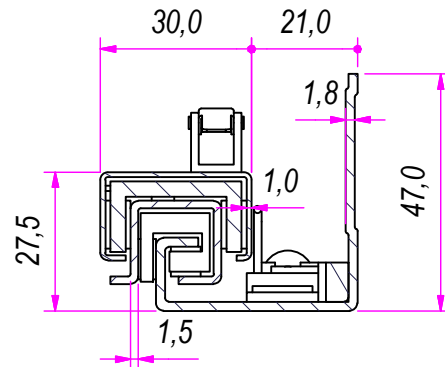

SEZ. A-A



DESIGNED BY F. Dino	CHECKED AND APPROVED BY L. Paleari	GENERAL TOLERANCE SS-ISO-2768-1M	DATE 28/03/2017	CODE Q21600
PACKAGING Carton 10 sets/Packed R+L			UNIT mm	SHEET 1 of 3
			MATERIAL Cold rolled steel	
			DESCRIPTION Soft self closing/Oil piston	PAIR WEIGHT 2,594 Kg

		REVISION HISTORY		
		REV	DESCRIPTION	DATE
Guide per cassetti; guide telescopiche	Coulisses à billes; coulisse télescopique			
Drawer slide; telescopic ball bearing slide	Guías para cajones; guía teleópica	1a		28/03/2017
Kugelführung; Teleskopschienen				

Property of RAM Industrie.  
Without its written authorization the present drawing shall neither be used for construction anyway, communicated to third parties, nor reproduced.

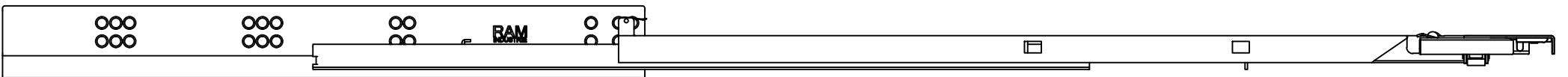
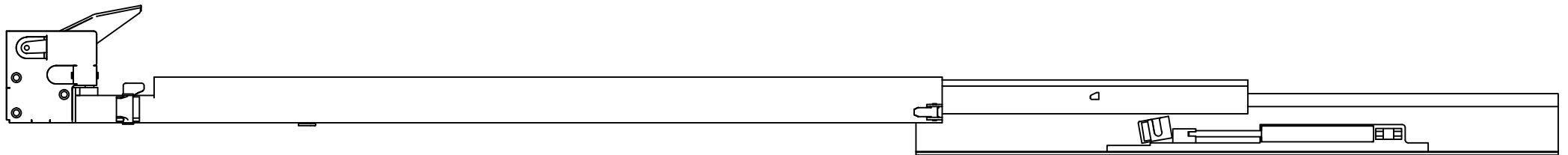
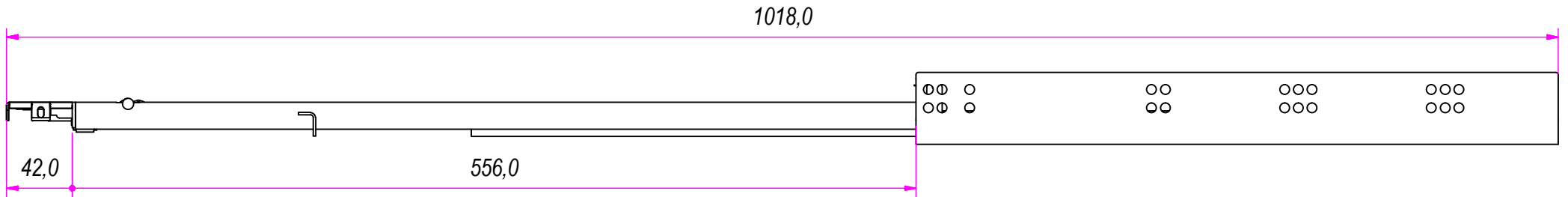
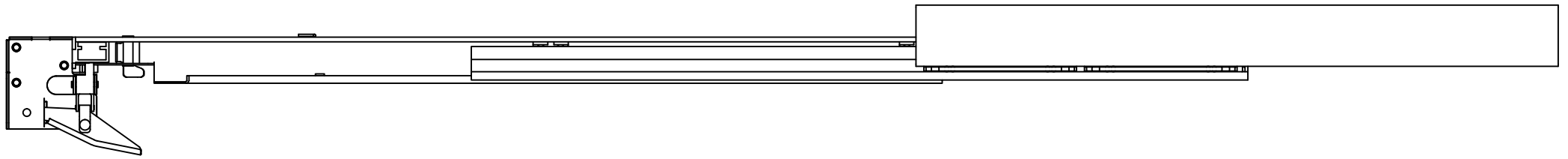

Guide per cassetti; guide telescopica	Coulisses à billes; coulisse télescopique
Drawer slide; telescopic ball bearing slide	Guías para cajones; guía teleópica
Kugelführung; Teleskopschienen	

REVISION HISTORY	
REV	DESCRIPTION
1a	

DESIGNED BY F. Dino	CHECKED AND APPROVED BY L. Paleari	GENERAL TOLLERANCE SS-ISO-2768-1M	DATE 28/03/2017	CODE Q21600
		PACKAGING Carton 10 sets/Packed R+L	UNIT mm	SHEET 2 of 3
		DESCRIPTION Soft self closing/Oil piston	MATERIAL Cold rolled steel	PAIR WEIGHT 2,594 Kg
		Without its written authorization the present drawing shall neither be used for construction anyway, communicated to third parties, nor reproduced.		

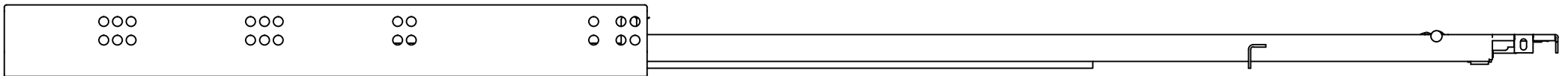
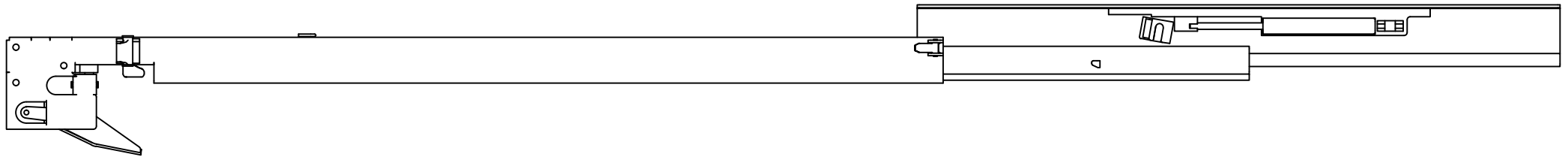
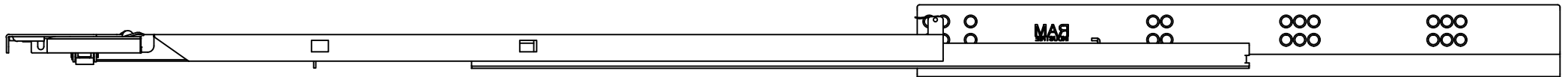
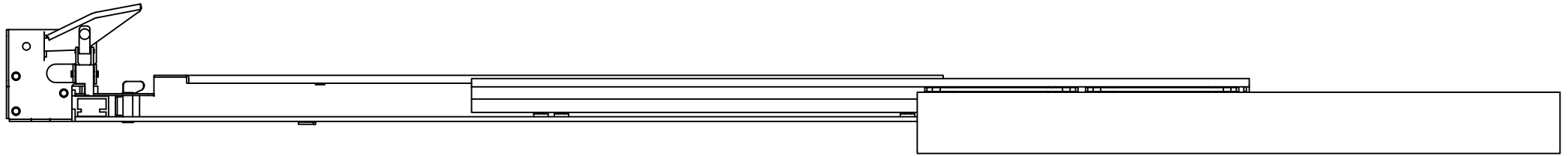

DESIGNED BY F.Dino	CHECKED AND APPROVED BY L. Paleari	GENERAL TOLERANCE SS-ISO-2768-1M	DATE 28/03/2017	CODE Q21600
		PACKAGING Carton 10 sets/Packed R+L	UNIT mm	SHEET 3 of 3
		DESCRIPTION Soft self closing/Oil piston	MATERIAL Cold rolled steel	PAIR WEIGHT 2,594 Kg
04C				
Property of RAM Industrie. Without its written authorization the present drawing shall neither be used for construction anyway, communicated to third parties, nor reproduced.				