

SEZ. A-A

B (1:1)

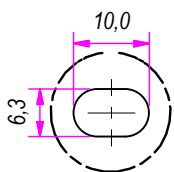

C (1:1)

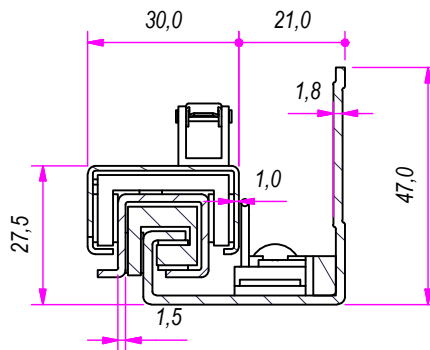
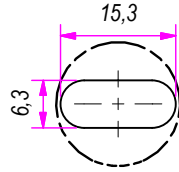

Guide per cassette; guide telescopiche	Coulisses à billes; coulisse télescopique	REVISION HISTORY	
Drawer slide; telescopic ball bearing slide	Guías para cajones; guía teleópica	REV	DESCRIPTION
Kugelführung; Teleskopschienen		1a	28/03/2017

DESIGNED BY		CHECKED AND APPROVED BY		GENERAL TOLERANCE		DATE		CODE	
F. Dino		L. Paleari		SS-ISO-2768-1M		28/03/2017		Q21500	
PACKAGING				UNIT		SHEET			
Carton 10 sets/Packed R+L				mm		1 of 3			
DESCRIPTION				MATERIAL					
Soft self closing/Oil piston				Cold rolled steel		04C			
				PAIR WEIGHT		PAIR WEIGHT WITH CARTON			
				2,14 Kg		2,227 Kg			

DESIGNED BY		CHECKED AND APPROVED BY		GENERAL TOLERANCE		DATE		CODE	
F. Dino		L. Paleari		SS-ISO-2768-1M		28/03/2017		Q21500	
PACKAGING				UNIT		SHEET			
Carton 10 sets/Packed R+L				mm		1 of 3			
DESCRIPTION				MATERIAL					
Soft self closing/Oil piston				Cold rolled steel		04C			
				PAIR WEIGHT		PAIR WEIGHT WITH CARTON			
				2,14 Kg		2,227 Kg			

Property of RAM Industrie.
Without its written authorization the present drawing shall neither be used for construction anyway, communicated to third parties, nor reproduced.

RAM
INDUSTRIE

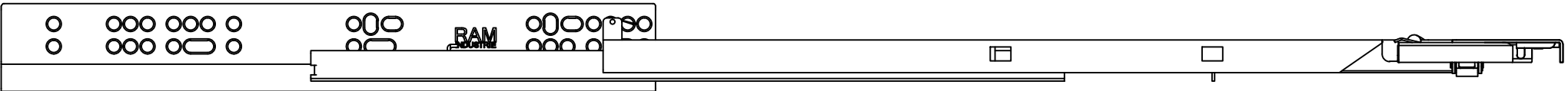
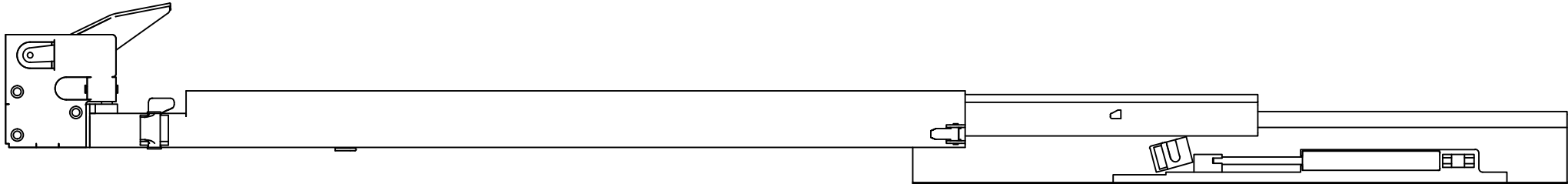
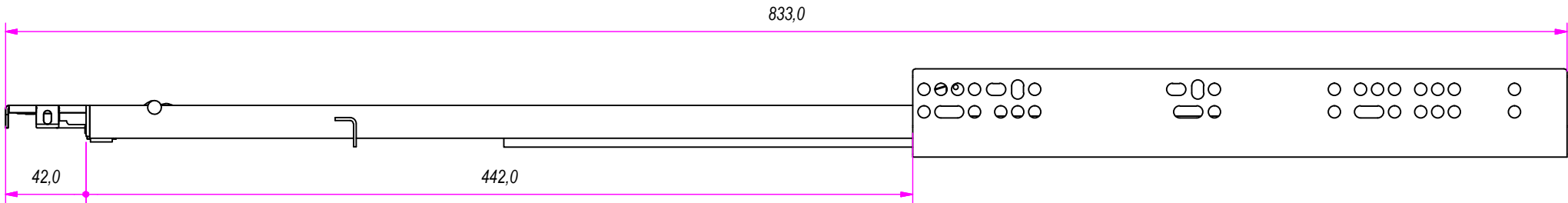
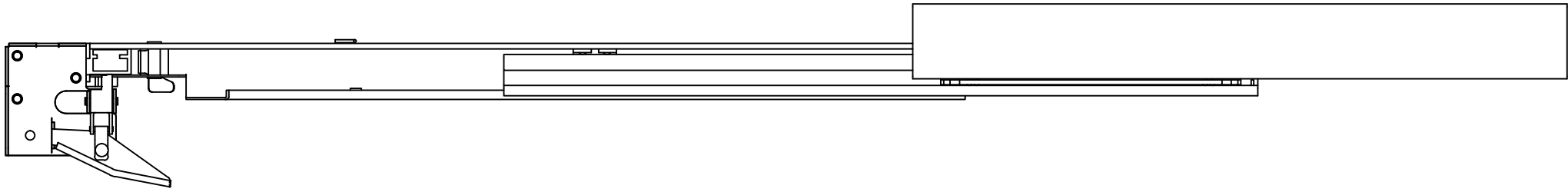

Guide per cassetti; guide telescopica	Coulisses à billes; coulisse télescopique
Drawer slide; telescopic ball bearing slide	Guías para cajones; guía teleópica
Kugelführung; Teleskopschienen	

REVISION HISTORY	
REV	DESCRIPTION
1a	

DESIGNED BY F. Dino	CHECKED AND APPROVED BY L. Paleari	GENERAL TOLERANCE SS-ISO-2768-1M	DATE 28/03/2017	CODE Q21500
		PACKAGING Carton 10 sets/Packed R+L	UNIT mm	SHEET 2 of 3
		DESCRIPTION Soft self closing/Oil piston	MATERIAL Cold rolled steel	04C
		PAIR WEIGHT 2,14 Kg	PAIR WEIGHT WITH CARTON 2,227 Kg	
Property of RAM Industrie. Without its written authorization the present drawing shall neither be used for construction anyway, communicated to third parties, nor reproduced.				

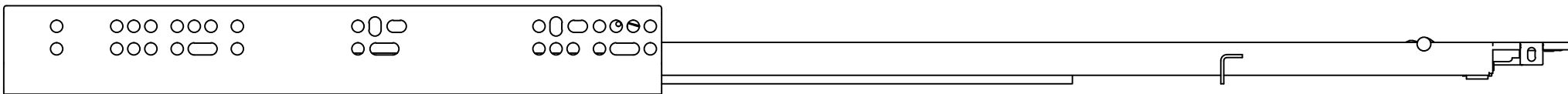
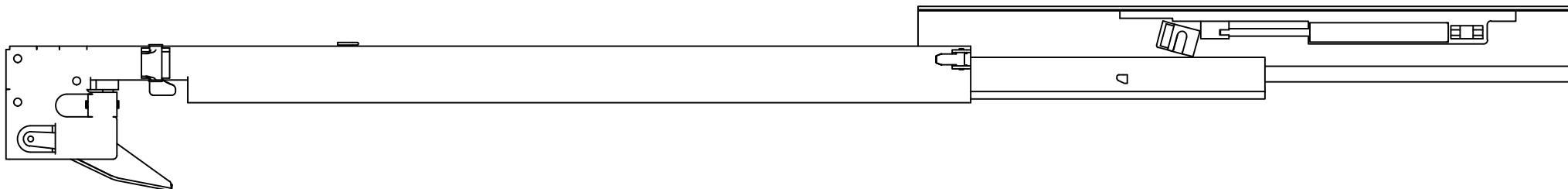
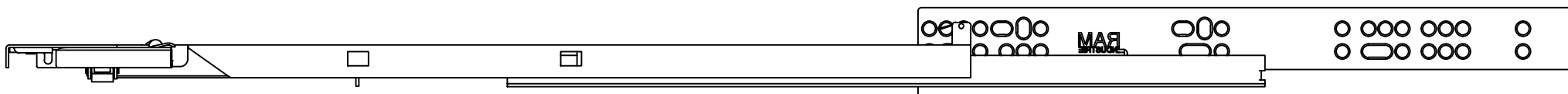
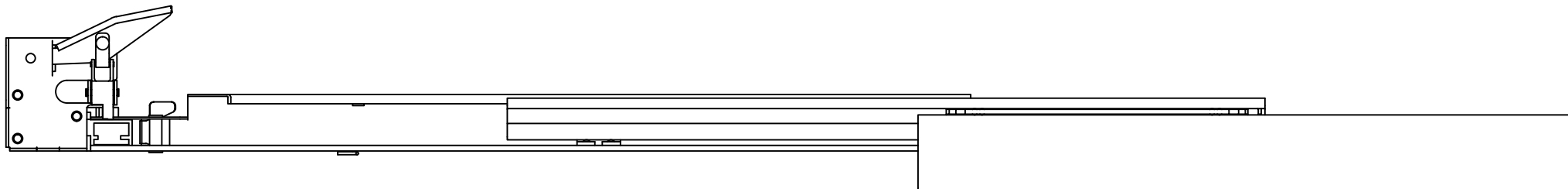

DESIGNED BY F.Dino	CHECKED AND APPROVED BY L. Paleari	GENERAL TOLLERANCE SS-ISO-2768-1M	DATE 28/03/2017	CODE Q21500
		PACKAGING Carton 10 sets/Packed R+L	UNIT mm	SHEET 3 of 3
		DESCRIPTION Soft self closing/Oil piston	MATERIAL Cold rolled steel	04C
		PAIR WEIGHT 2,14 Kg	PAIR WEIGHT WITH CARTON 2,227 Kg	

Property of RAM Industrie.
Without its written authorization the present drawing shall neither be used for construction anyway, communicated to third parties, nor reproduced.