

DESIGNED BY F. Dino	CHECKED AND APPROVED BY L. Paleari	GENERAL TOLERANCE SS-ISO-2768-1M	DATE 28/03/2017	CODE Q21250
PACKAGING Carton 10 sets/Packed R+L			UNIT mm	SHEET 1 of 3
DESCRIPTION RAM INDUSTRIE			MATERIAL Cold rolled steel	
DEVICE Soft self closing/Oil piston			PAIR WEIGHT 1,266 Kg	04C

		REVISION HISTORY		
		REV	DESCRIPTION	DATE
Guide per cassetti; guide telescopiche	Coulisses à billes; coulisse télescopique			
Drawer slide; telescopic ball bearing slide	Guías para cajones; guía teleópica	1a		28/03/2017
Kugelführung; Teleskopschienen				

Property of RAM Industrie.
Without its written authorization the present drawing shall neither be used for construction anyway, communicated to third parties, nor reproduced.

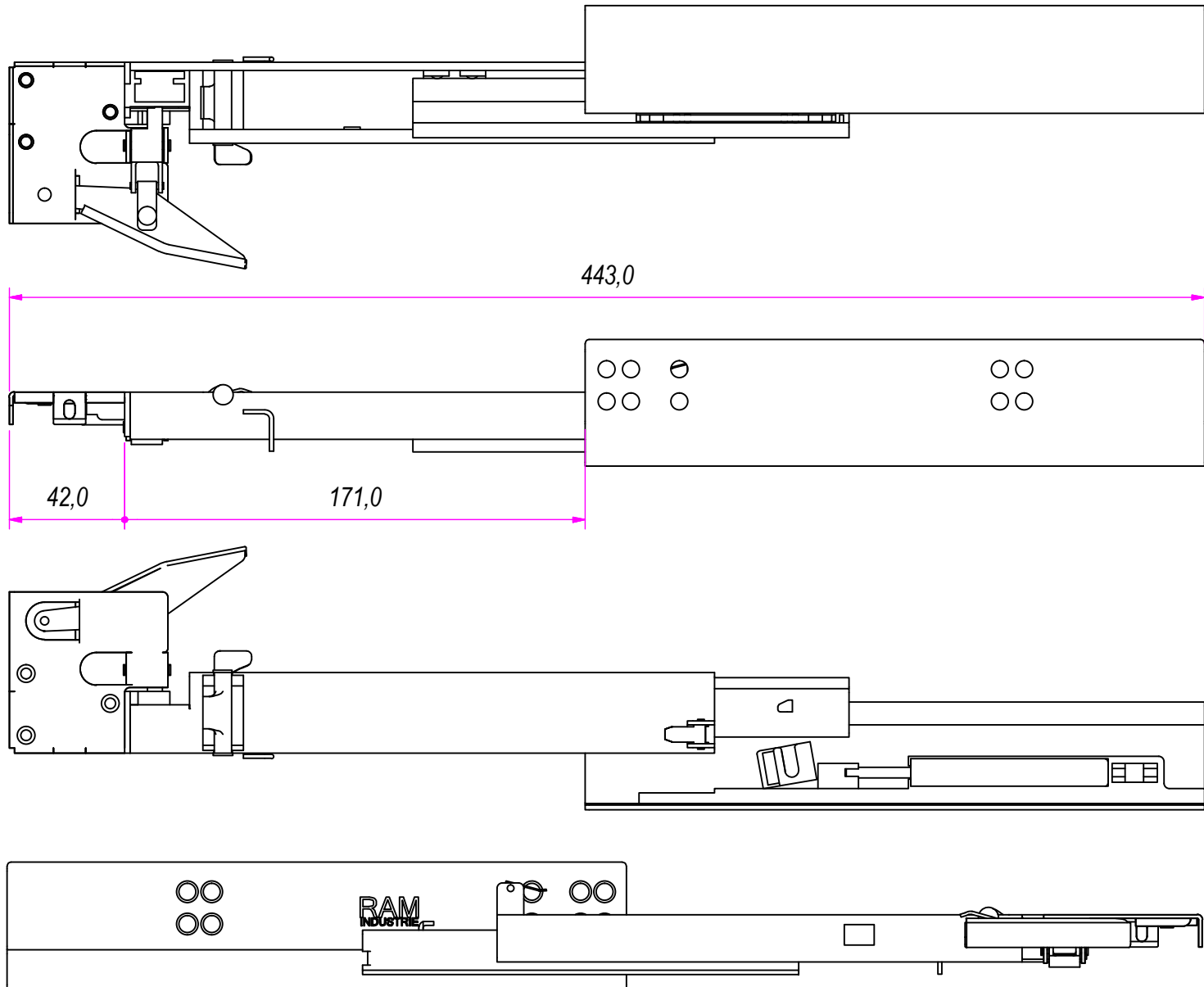

Guide per cassetti; guide telescopica	Coulisses à billes; coulisse télescopique	
Drawer slide; telescopic ball bearing slide	Guías para cajones; guía teleópica	
Kugelführung; Teleskopschienen		

REVISION HISTORY		
REV	DESCRIPTION	DATE
1a		28/03/2017

DESIGNED BY F. Dino	CHECKED AND APPROVED BY L. Paleari	GENERAL TOLERANCE SS-ISO-2768-1M	DATE 28/03/2017	CODE Q21250
		PACKAGING Carton 10 sets/Packed R+L	UNIT mm	SHEET 2 of 3
		DESCRIPTION Soft self closing/Oil piston	MATERIAL Cold rolled steel	
		PAIR WEIGHT 1,266 Kg	04C	
<small>Property of RAM Industrie. Without its written authorization the present drawing shall neither be used for construction anyway, communicated to third parties, nor reproduced.</small>				

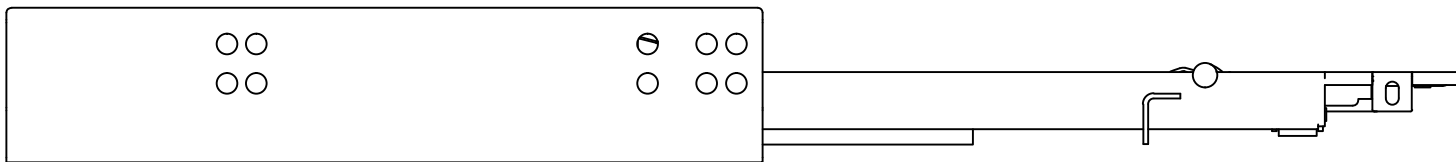
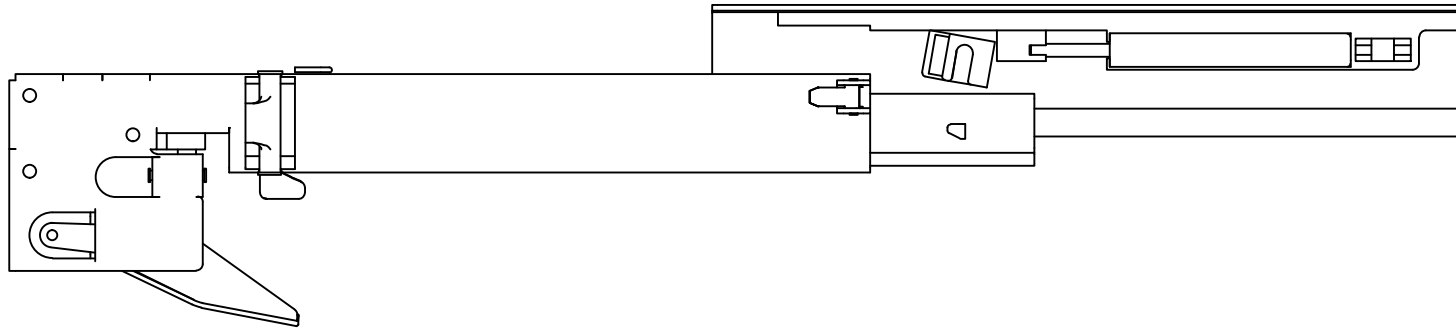
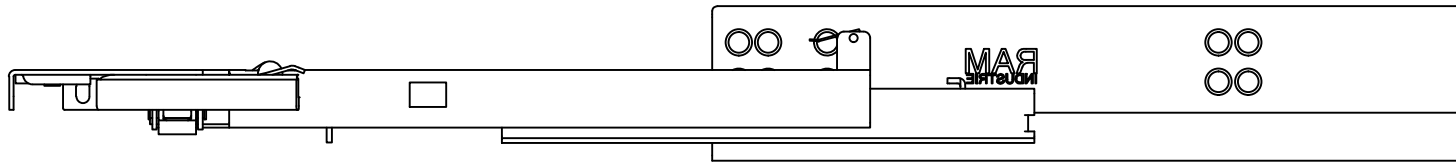
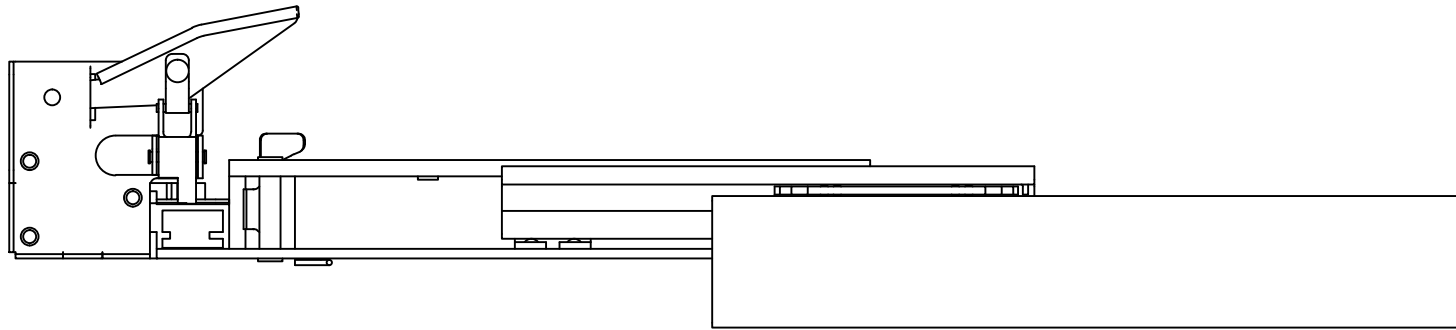

DESIGNED BY F. Dino	CHECKED AND APPROVED BY L. Paleari	GENERAL TOLERANCE SS-ISO-2768-1M	DATE 28/03/2017	CODE Q21250	
			PACKAGING Carton 10 sets/Packed R+L	UNIT mm	SHEET 3 of 3
			DESCRIPTION Soft self closing/Oil piston	MATERIAL Cold rolled steel	PAIR WEIGHT 1,266 Kg

Property of RAM Industrie.
Without its written authorization the present drawing shall neither be used for construction anyway, communicated to third parties, nor reproduced.