

SEZ. A-A

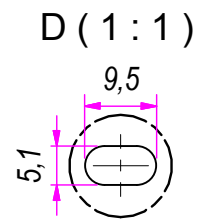

DESIGNED BY F.Dino	CHECKED AND APPROVED BY L. Paleari	REVISION	DATE 16/06/2016	CODE NE85750
		GENERAL TOLERANCE SS-ISO-2768-1M	UNIT mm	SCALE 1 of 2
		DESCRIPTION Black finishing (cataphoresis coating)	MATERIAL Cold rolled steel	
DEVICE			PAIR WEIGHT 7,422 Kg	02C
<small>Property of RAM Industrie. Without its written authorization the present drawing shall neither be used for construction anyway, communicated to third parties, nor reproduced.</small>				

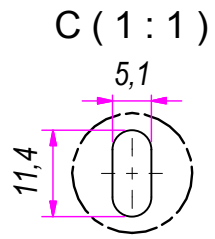
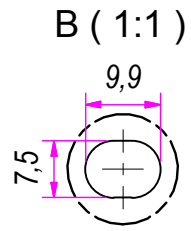
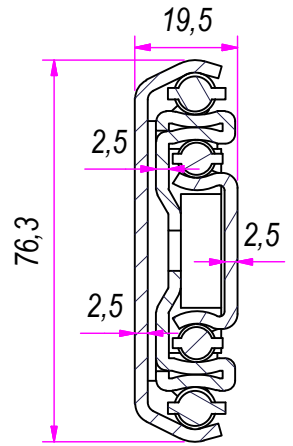
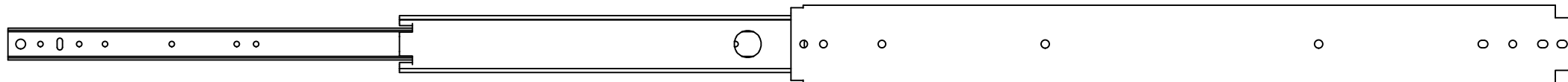

1522,0

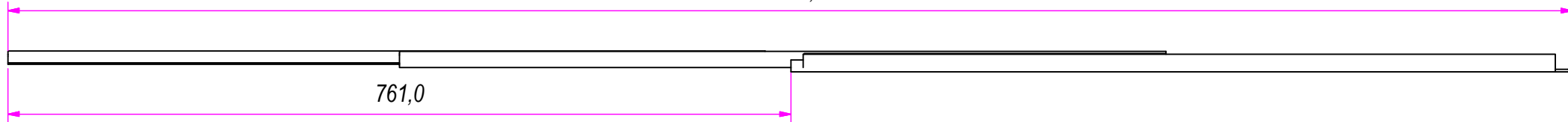

761,0

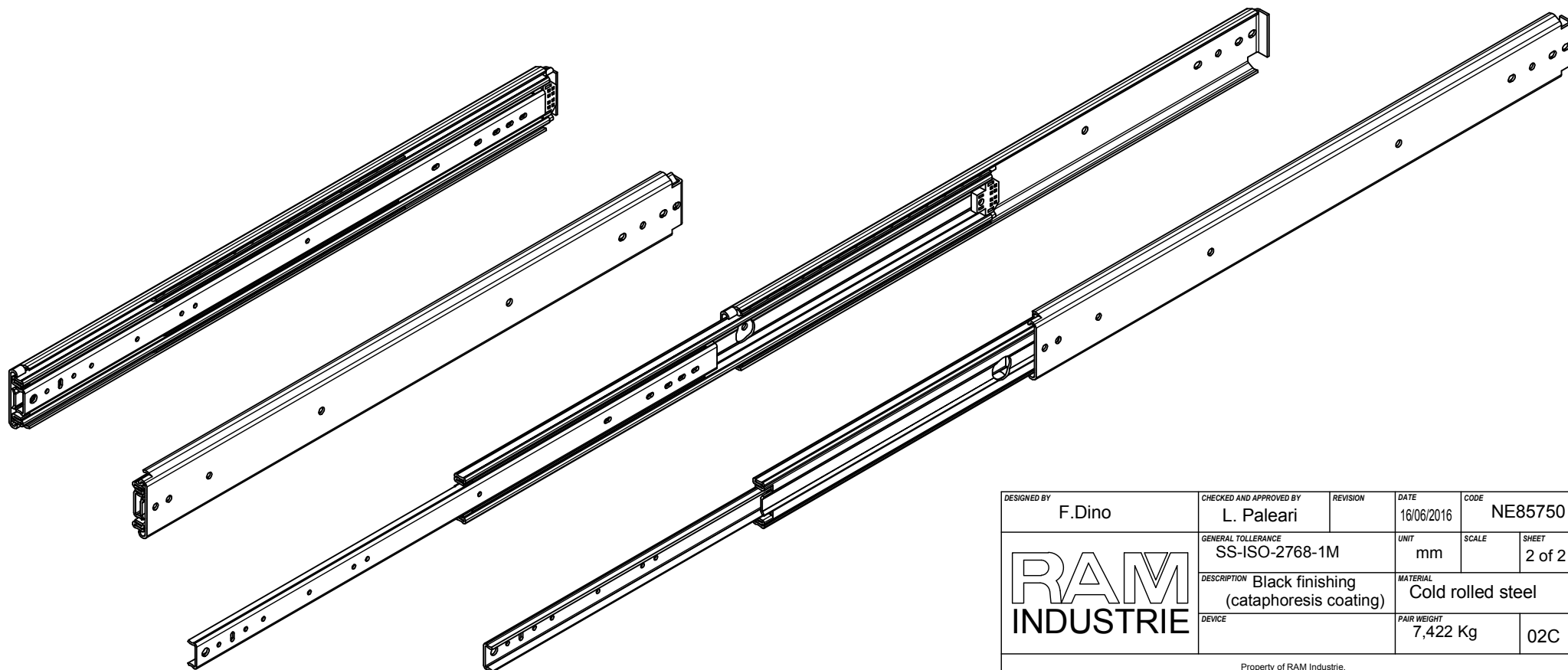
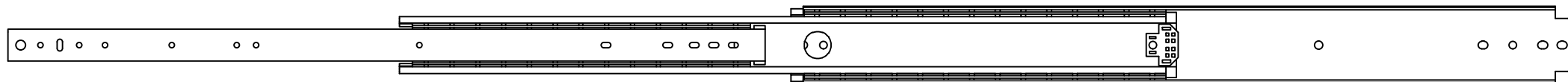

DESIGNED BY F.Dino	CHECKED AND APPROVED BY L. Paleari	REVISION	DATE 16/06/2016	CODE NE85750
GENERAL TOLLERANCE SS-ISO-2768-1M		UNIT mm	SCALE	SHEET 2 of 2
DESCRIPTION Black finishing (cataphoresis coating)		MATERIAL Cold rolled steel		
DEVICE		PAIR WEIGHT 7,422 Kg	02C	

Property of RAM Industrie.
Without its written authorization the present drawing shall neither be used for construction anyway, communicated to third parties, nor reproduced.