

SEZ. A-A

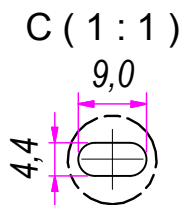

DESIGNED BY F.Dino	CHECKED AND APPROVED BY L. Paleari	REVISION	DATE 10/06/2016	CODE NE51400
GENERAL TOLLERANCE SS-ISO-2768-1M			UNIT mm	SCALE SHEET 1 of 2
DESCRIPTION Black finishing (cataphoresis coating)			MATERIAL Cold rolled steel	
DEVICE Clip on bracket			PAIR WEIGHT 1,62 Kg	02C

Property of RAM Industrie.
Without its written authorization the present drawing shall neither be used for construction anyway, communicated to third parties, nor reproduced.

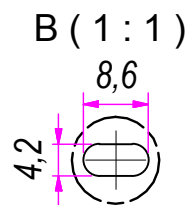
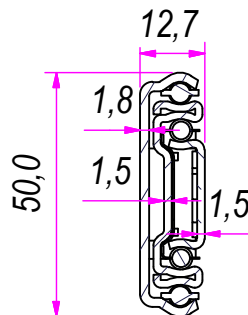
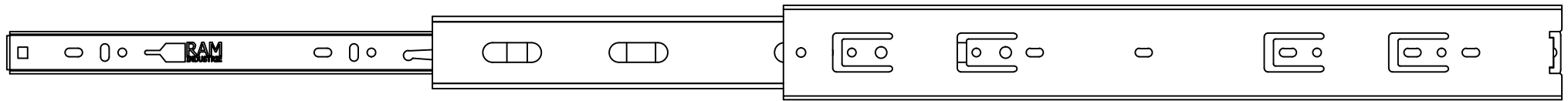

800,0

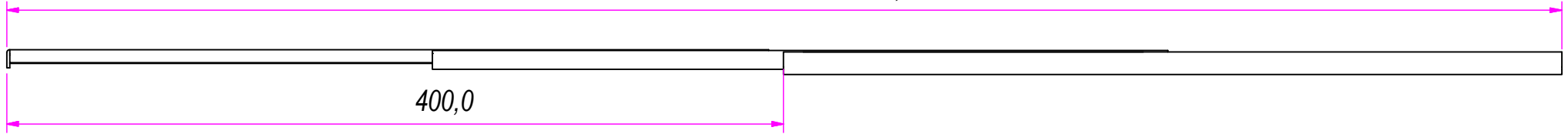

400,0

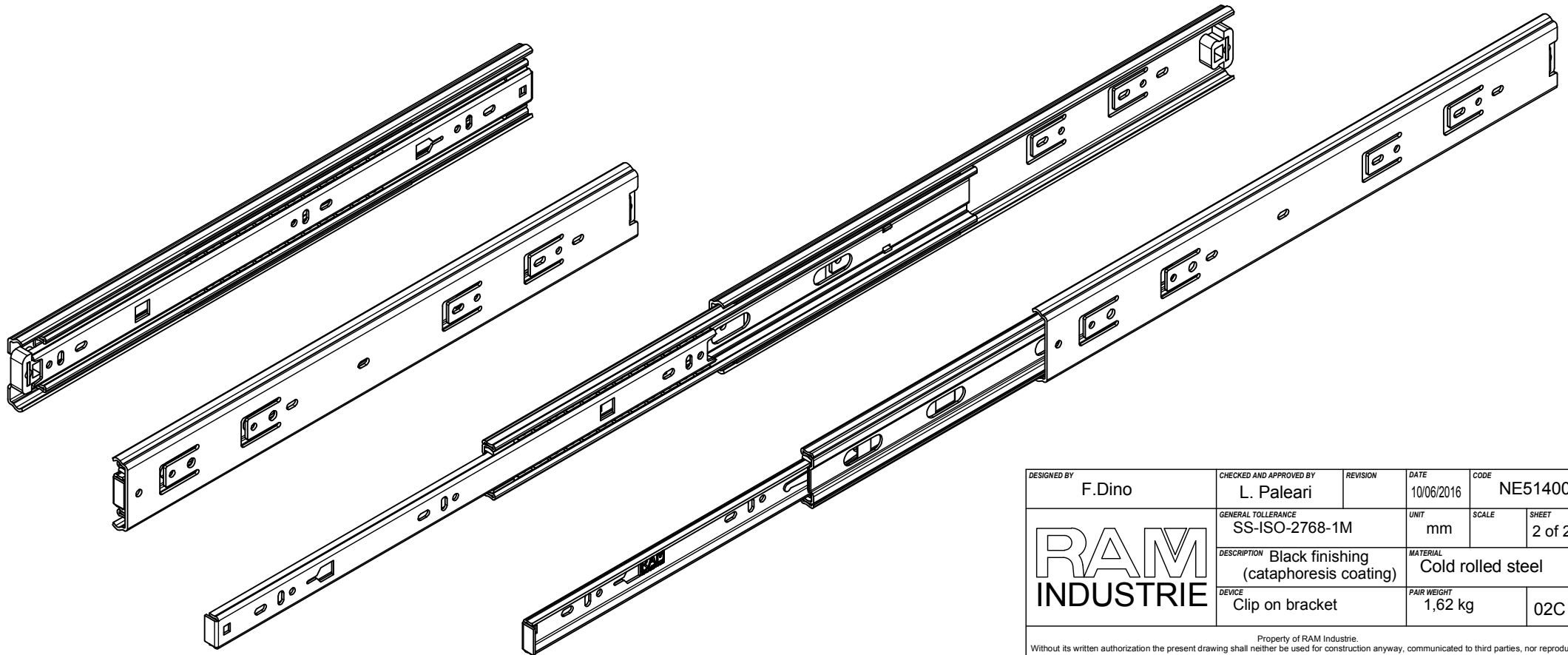
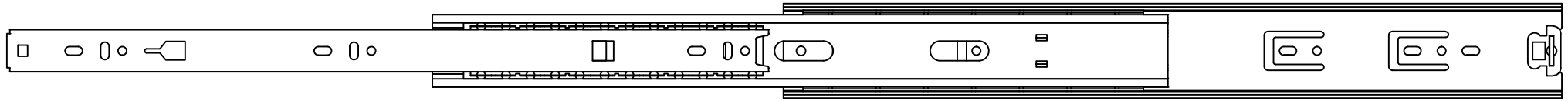

DESIGNED BY F.Dino	CHECKED AND APPROVED BY L. Paleari	REVISION	DATE 10/06/2016	CODE NE51400
GENERAL TOLLERANCE SS-ISO-2768-1M			UNIT mm	SHEET 2 of 2
			DESCRIPTION Black finishing (cataphoresis coating)	
			MATERIAL Cold rolled steel	
DEVICE Clip on bracket			PAIR WEIGHT 1,62 kg	02C

Property of RAM Industrie.
Without its written authorization the present drawing shall neither be used for construction anyway, communicated to third parties, nor reproduced.