

SEZ. A-A

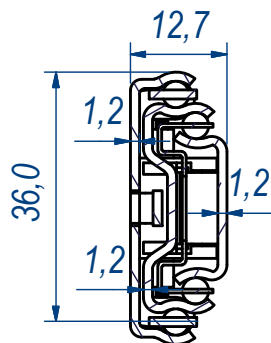

B (1:1)

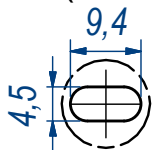

E (1:1)

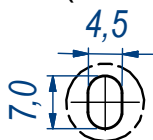

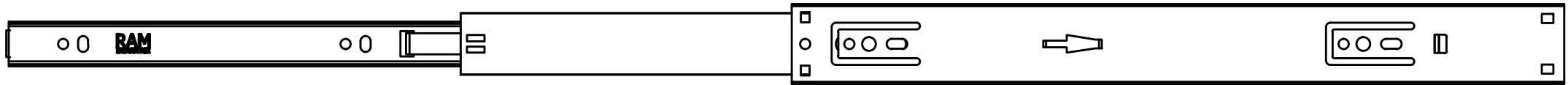

DESIGNED BY F.Dino	CHECKED AND APPROVED BY L. Paleari	REVISION	DATE 28/06/2016	CODE LO62350
GENERAL TOLERANCE SS-ISO-2768-1M		UNIT mm	SCALE	SHEET 1 of 2
		MATERIAL Zinc coated steel		
		DESCRIPTION Lock-out Self closing with double spring		PAIR WEIGHT 0,796 Kg

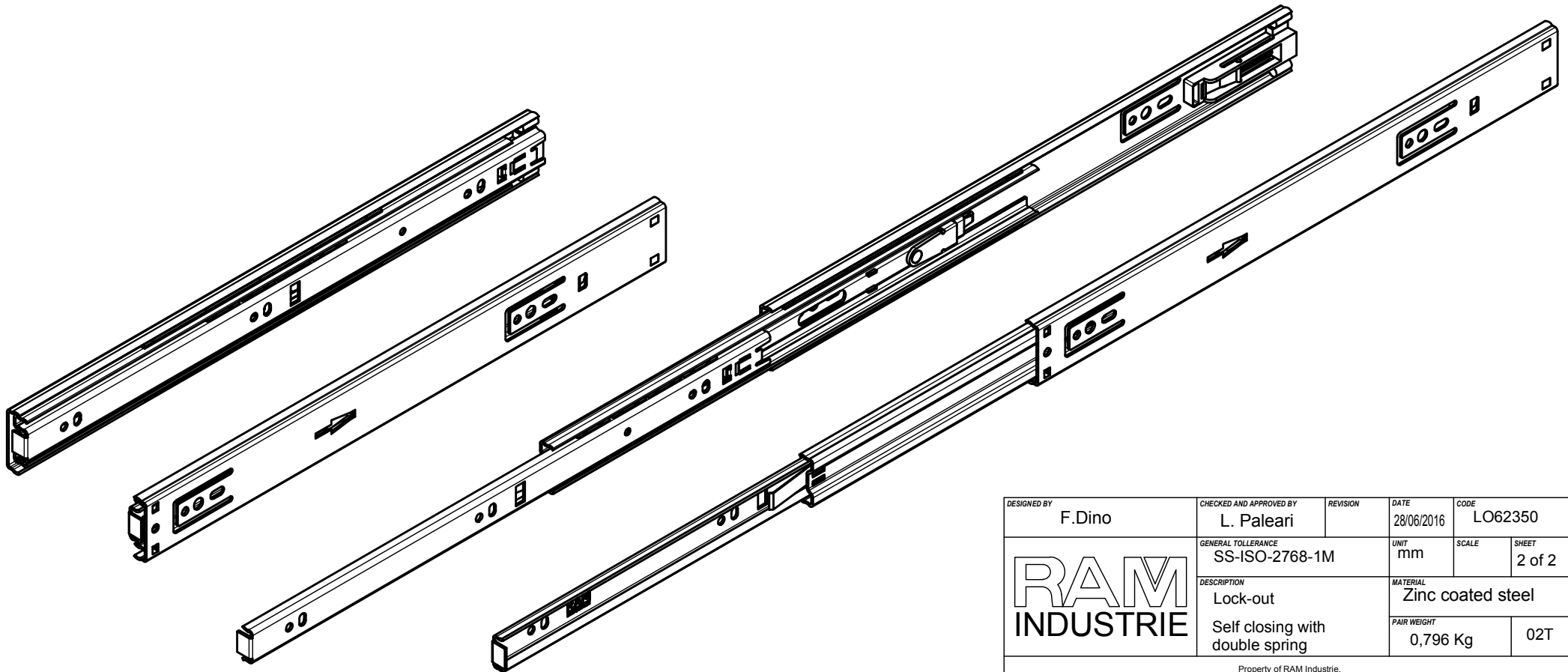
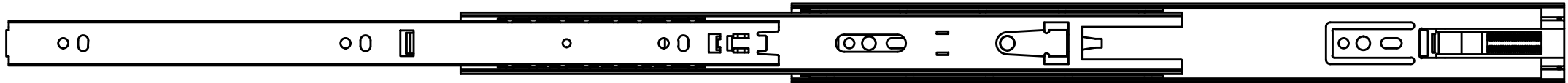
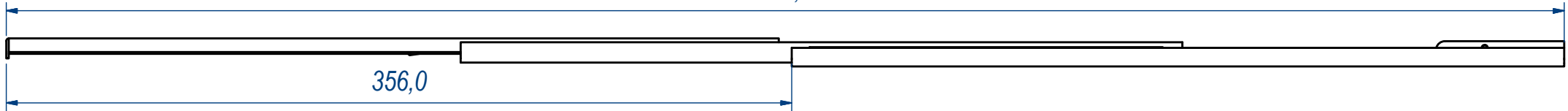

706,0

356,0



DESIGNED BY F.Dino	CHECKED AND APPROVED BY L. Paleari	REVISION	DATE 28/06/2016	CODE LO62350
GENERAL TOLLERANCE SS-ISO-2768-1M		UNIT mm	SCALE	SHEET 2 of 2
		DESCRIPTION Lock-out		MATERIAL Zinc coated steel
		Self closing with double spring		PAIR WEIGHT 0,796 Kg

Property of RAM Industrie.
Without its written authorization the present drawing shall neither be used for construction anyway, communicated to third parties, nor reproduced.