

SEZ. A-A

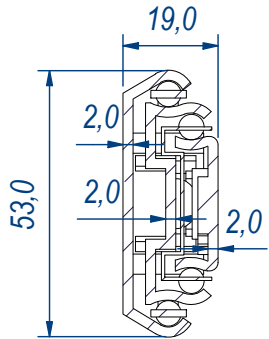

B (1:1)

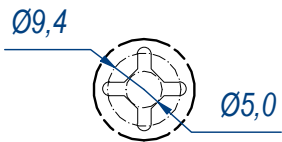

C (1:1)

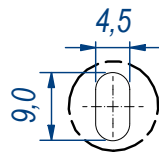

DESIGNED BY F.Dino	CHECKED AND APPROVED BY L. Paleari	REVISION	DATE 23/03/2016	CODE LE58550
GENERAL TOLERANCE SS-ISO-2768-1M			UNIT mm	SCALE 1 of 2
DESCRIPTION			MATERIAL Zinc coated steel	
DEVICE Lock-in and lock-out			PAIR WEIGHT 3,028 Kg	02C

Property of RAM Industrie.  
Without its written authorization the present drawing shall neither be used for construction anyway, communicated to third parties, nor reproduced.

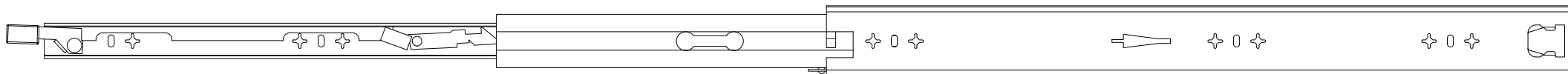

1119,0

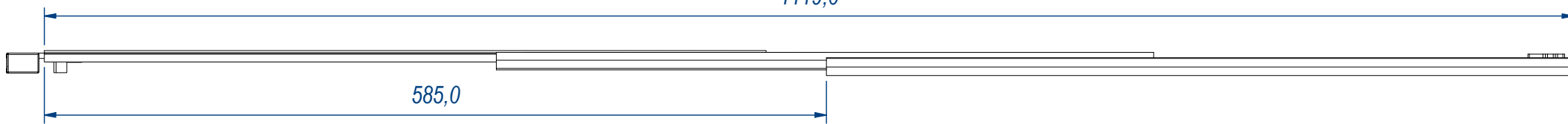

585,0

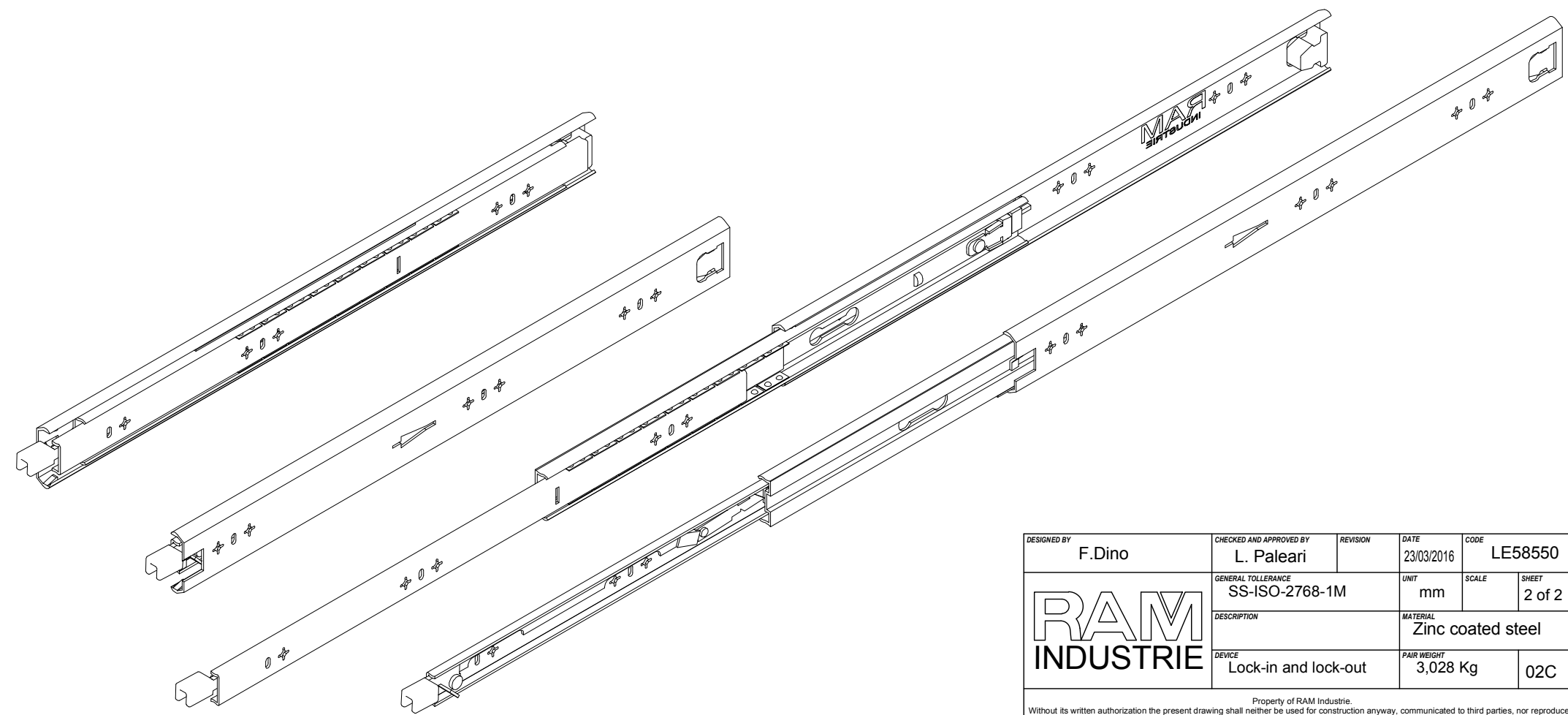
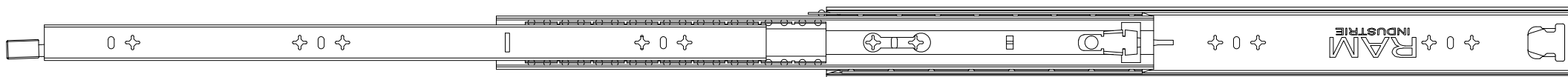

DESIGNED BY <b>F.Dino</b>	CHECKED AND APPROVED BY <b>L. Paleari</b>	REVISION	DATE 23/03/2016	CODE <b>LE58550</b>
		GENERAL TOLLERANCE SS-ISO-2768-1M	UNIT mm	SCALE SHEET 2 of 2
		DESCRIPTION Lock-in and lock-out	MATERIAL Zinc coated steel	PAIR WEIGHT 3,028 Kg

Property of RAM Industrie.  
Without its written authorization the present drawing shall neither be used for construction anyway, communicated to third parties, nor reproduced.