

SEZ. A-A

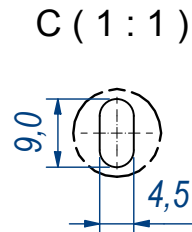

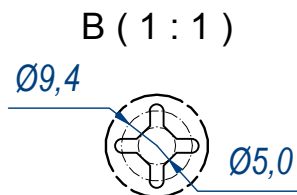

DESIGNED BY F.Dino	CHECKED AND APPROVED BY L. Paleari	REVISION	DATE 23/03/2016	CODE LE58350
		GENERAL TOLLERANCE SS-ISO-2768-1M	UNIT mm	SCALE 1 of 2
		DESCRIPTION Lock-in and lock-out	MATERIAL Zinc coated steel	
		PAIR WEIGHT 1,886 Kg	02C	

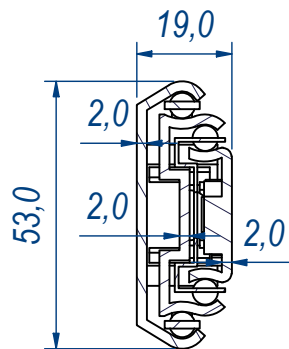
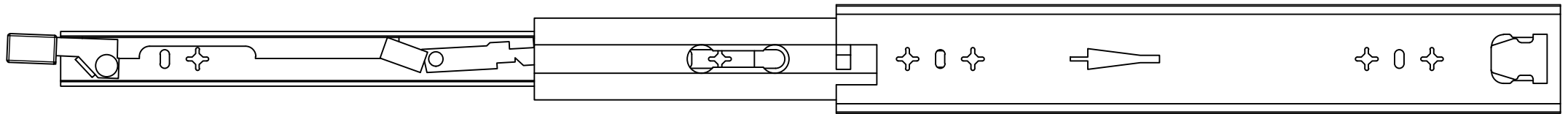

735,0

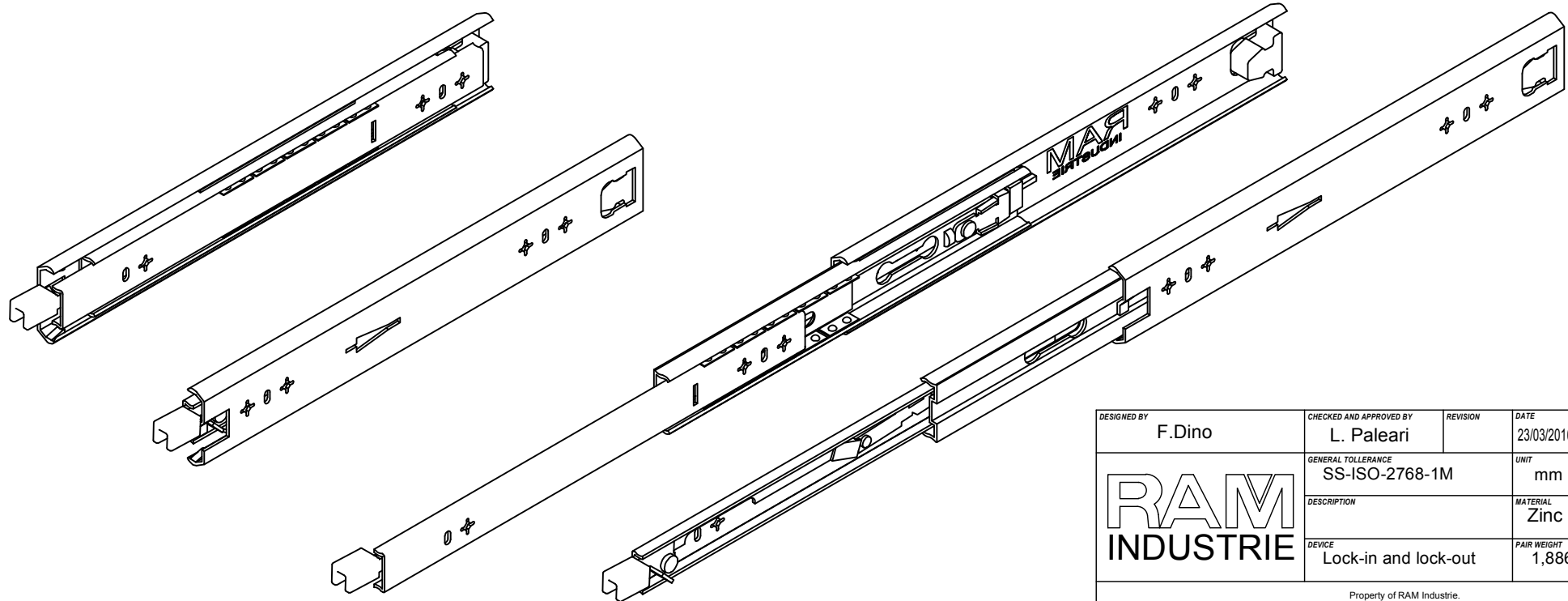
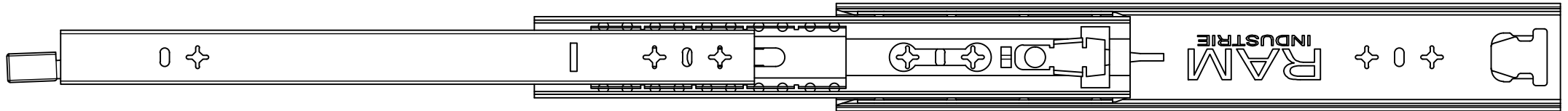
380,0



DESIGNED BY F.Dino	CHECKED AND APPROVED BY L. Paleari	REVISION	DATE 23/03/2016	CODE LE58350
GENERAL TOLERANCE SS-ISO-2768-1M			UNIT mm	SHEET 2 of 2
			MATERIAL Zinc coated steel	
			DEVICE Lock-in and lock-out	PAIR WEIGHT 1,886 Kg

Property of RAM Industrie.
Without its written authorization the present drawing shall neither be used for construction anyway, communicated to third parties, nor reproduced.