

DESIGNED BY F.Dino	CHECKED AND APPROVED BY L. Paleari	REVISION	DATE 20/07/2016	CODE I26550
GENERAL TOLLERANCE SS-ISO-2768-1M		UNIT mm	SCALE	SHEET 1 of 2
DESCRIPTION		MATERIAL Stainless steel AISI 304		
DEVICE		PAIR WEIGHT 0,712 Kg	07C	

Property of RAM Industrie.
Without its written authorization the present drawing shall neither be used for construction anyway, communicated to third parties, nor reproduced.

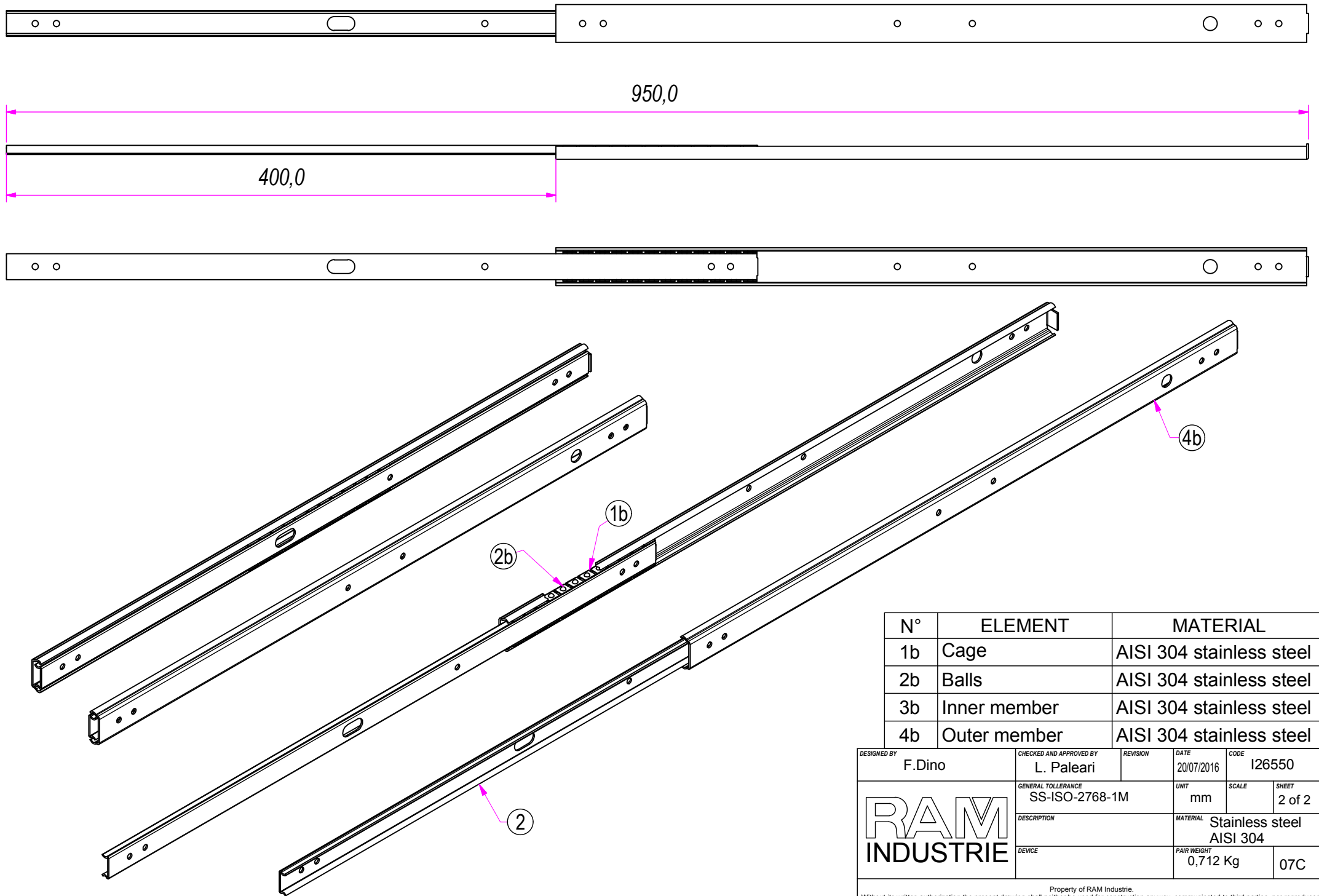

N°	ELEMENT	MATERIAL
1b	Cage	AISI 304 stainless steel
2b	Balls	AISI 304 stainless steel
3b	Inner member	AISI 304 stainless steel
4b	Outer member	AISI 304 stainless steel

DESIGNED BY F.Dino	CHECKED AND APPROVED BY L. Paleari	REVISION	DATE 20/07/2016	CODE I26550
		GENERAL TOLLERANCE SS-ISO-2768-1M	UNIT mm	SCALE SHEET 2 of 2
		DESCRIPTION	MATERIAL Stainless steel AISI 304	
		DEVICE	PAIR WEIGHT 0,712 Kg	07C

Property of RAM Industrie.
Without its written authorization the present drawing shall neither be used for construction anyway, communicated to third parties, nor reproduced.