

D (1:1)

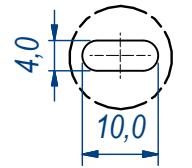

E (1:1)

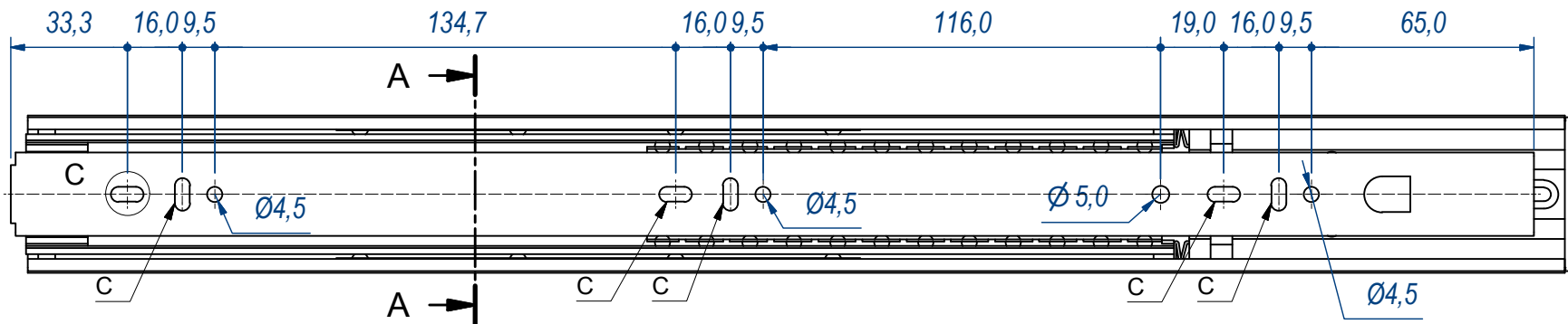
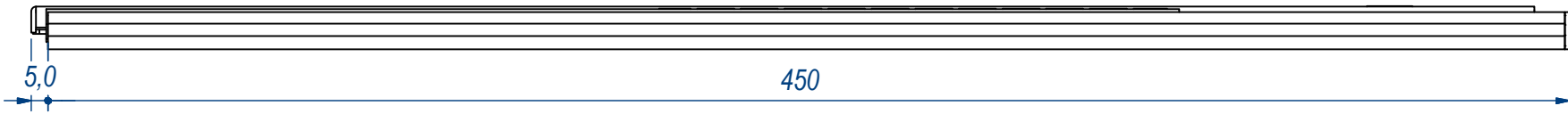
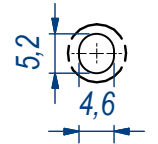

SEZ. A-A

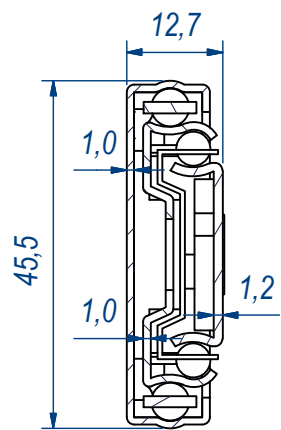

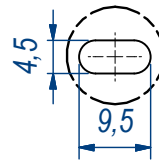
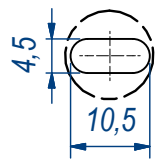

B (1:1) C (1:1)



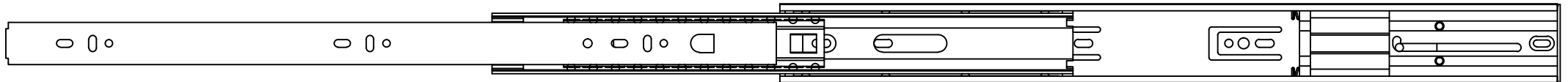
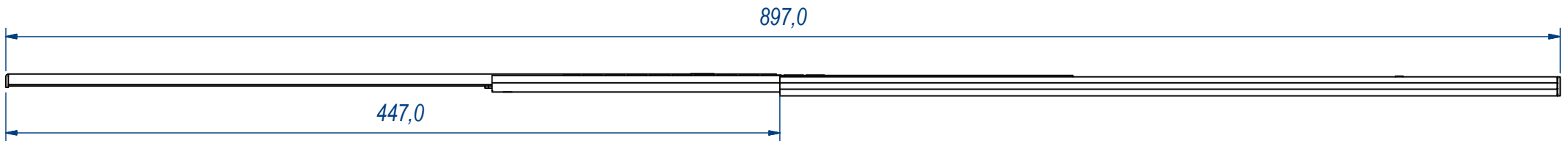
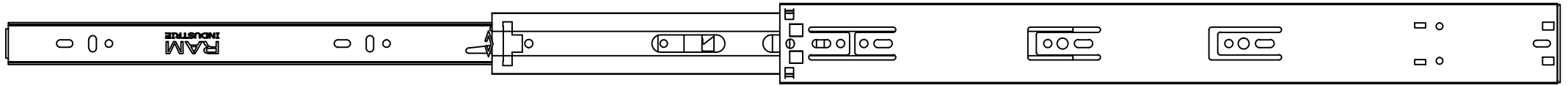

DESIGNED BY F.Dino	CHECKED AND APPROVED BY L. Paleari	REVISION	DATE 25/02/2016	CODE G41450
		GENERAL TOLLERANCE SS-ISO-2768-1M	UNIT mm	SCALE SHEET 1 of 3
		DESCRIPTION	MATERIAL Zinc coated steel	
DEVICE Push and rebound system		PAIR WEIGHT 1,156 Kg	04C	
Property of RAM Industrie. Without its written authorization the present drawing shall neither be used for construction anyway, communicated to third parties, nor reproduced.				

REVISION HISTORY			
REV	DESCRIPTION	APPROVED BY	DATE
1	Added slotted hole (16-03)	F.Dino	22/09/2016

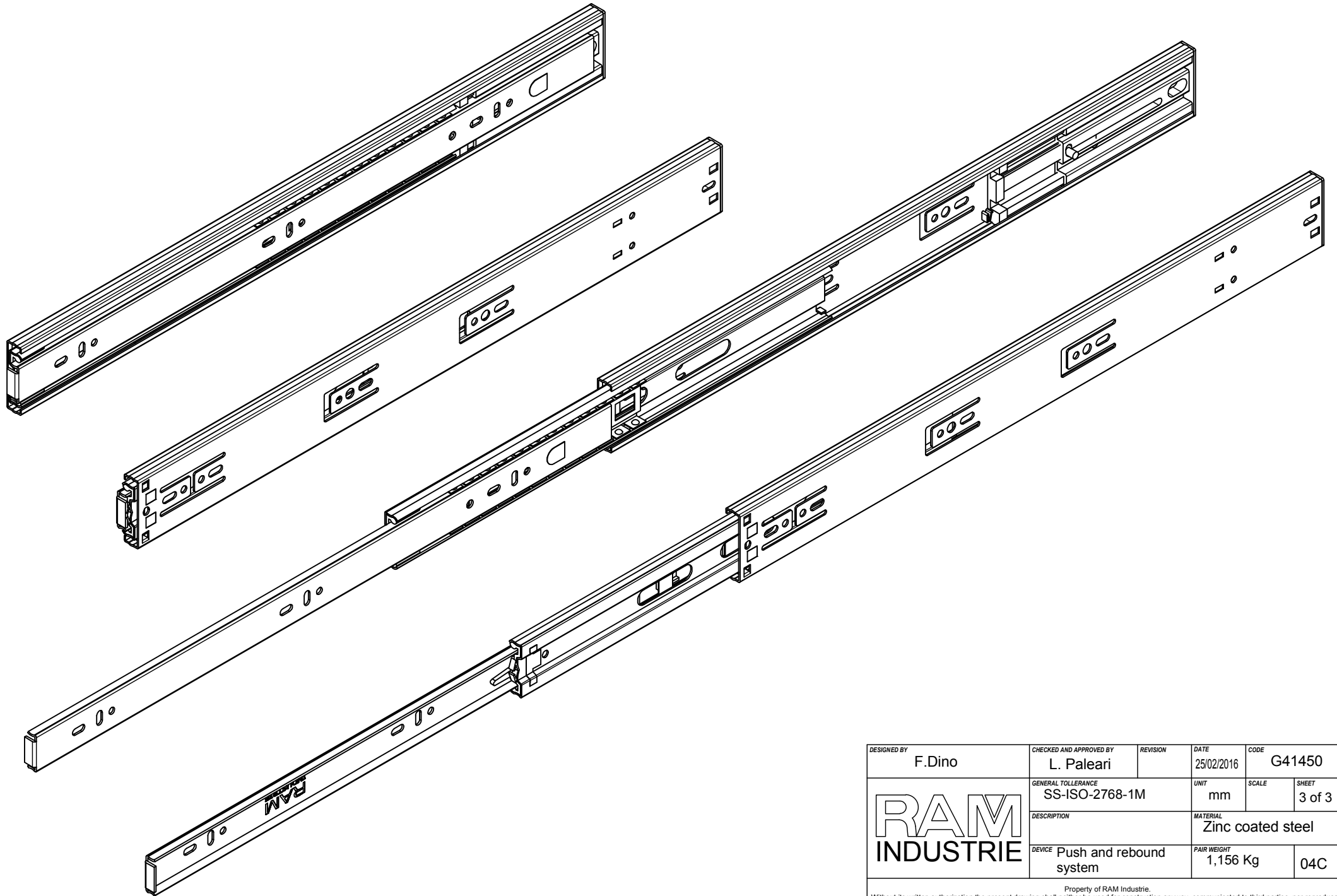

DESIGNED BY F.Dino	CHECKED AND APPROVED BY L. Paleari	REVISION	DATE 25/02/2016	CODE G41450
	GENERAL TOLLERANCE SS-ISO-2768-1M	UNIT mm	SCALE	SHEET 2 of 3
	DESCRIPTION	MATERIAL Zinc coated steel		
	DEVICE Push and rebound system	PAIR WEIGHT 1,156 Kg	04C	
<small>Property of RAM Industrie. Without its written authorization the present drawing shall neither be used for construction anyway, communicated to third parties, nor reproduced.</small>				



DESIGNED BY F.Dino	CHECKED AND APPROVED BY L. Paleari	REVISION	DATE 25/02/2016	CODE G41450
		GENERAL TOLLERANCE SS-ISO-2768-1M	UNIT mm	SCALE 3 of 3
		DESCRIPTION	MATERIAL Zinc coated steel	
DEVICE Push and rebound system		PAIR WEIGHT 1,156 Kg	04C	

Property of RAM Industrie.
Without its written authorization the present drawing shall neither be used for construction anyway, communicated to third parties, nor reproduced.