

REVISION HISTORY			
REV	DESCRIPTION	APPROVED BY	DATE
1		F.Dino	02/02/2017

DESIGNED BY F.Dino	CHECKED AND APPROVED BY L. Paleari	DATE 02/02/2017	CODE C35200	
		GENERAL TOLLERANCE SS-ISO-2768-1M	UNIT mm	SCALE 1 of 2
		DESCRIPTION	MATERIAL Cold rolled steel	
DEVICE		PAIR WEIGHT 1,206 Kg	02C	
Property of RAM Industrie. Without its written authorization the present drawing shall neither be used for construction anyway, communicated to third parties, nor reproduced.				

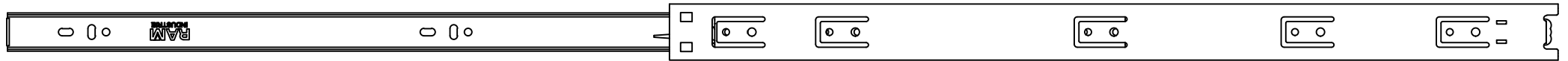

960,0

410,0

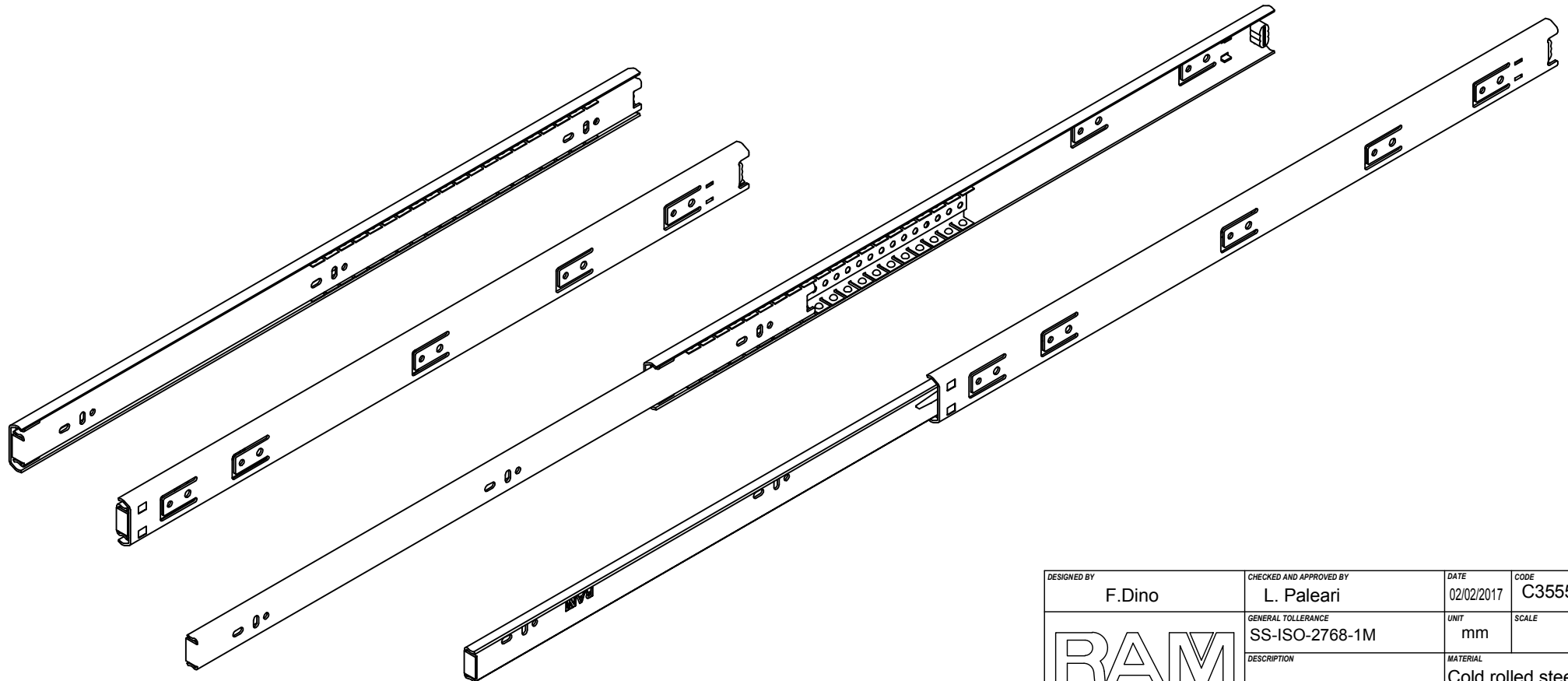
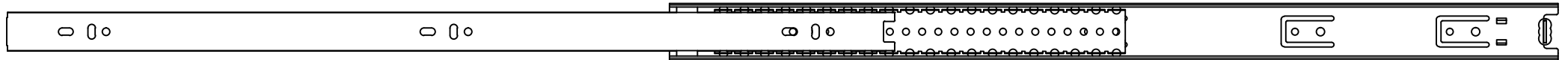

REVISION HISTORY			
REV	DESCRIPTION	APPROVED BY	DATE
1		F.Dino	02/02/2017

DESIGNED BY F.Dino	CHECKED AND APPROVED BY L. Paleari	DATE 02/02/2017	CODE C35550	
		GENERAL TOLLERANCE SS-ISO-2768-1M	UNIT mm	SCALE SHEET 2 of 2
		DESCRIPTION	MATERIAL Cold rolled steel	
DEVICE	PAIR WEIGHT 1,206 Kg		02C	

Property of RAM Industrie.
Without its written authorization the present drawing shall neither be used for construction anyway, communicated to third parties, nor reproduced.