

SEZ. A-A

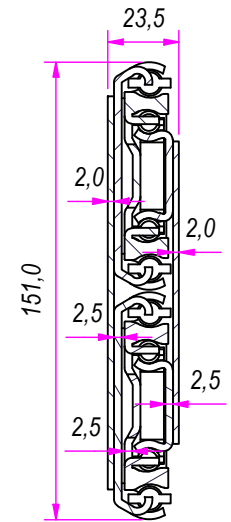

B (1:1.5)

C (1:1.5)

D (1:1.5)

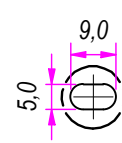
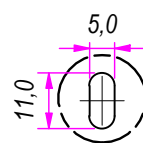
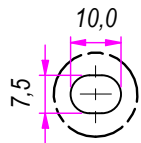

DESIGNED BY F. Dino	CHECKED AND APPROVED BY L. Paleari	GENERAL TOLERANCE SS-ISO-2768-1M	DATE 06/03/2017	CODE
PACKAGING			UNIT mm	SHEET 1 of 3
DESCRIPTION			MATERIAL Cold rolled steel	
DEVICE			PAIR WEIGHT	

RAM
INDUSTRIE

GUIDE PER CASSETTI; GUIDE TELESCOPICHE		COULISSES À BILLES; COULISSE TÉLESCOPIQUE		REVISION HISTORY	
DRAWER SLIDE; TELESCOPIC BALL BEARING SLIDE		GUÍAS PARA CAJONES; GUÍA TELEÓPICA		DESCRIPTION	DATE
Kugelführung; Teleskopschienen				REV 1a	06/03/2017

Property of RAM Industrie.
Without its written authorization the present drawing shall neither be used for construction anyway, communicated to third parties, nor reproduced.

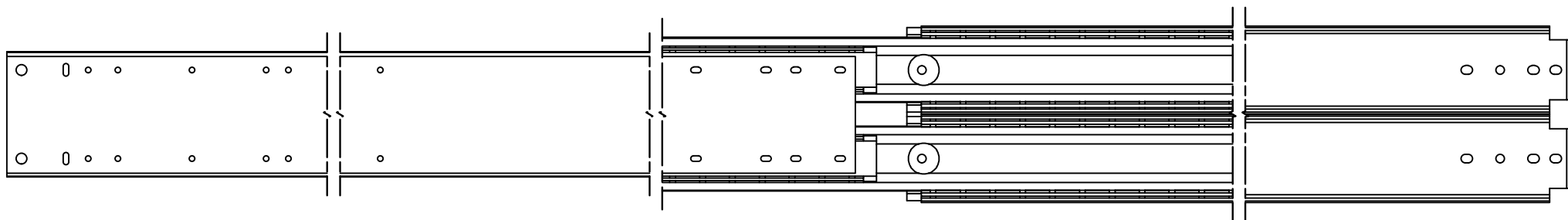
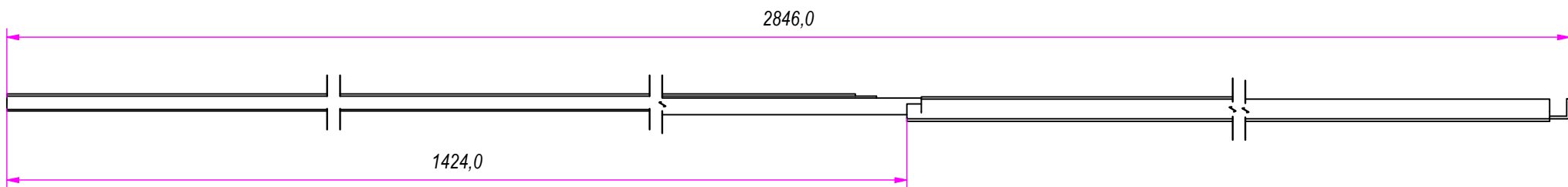
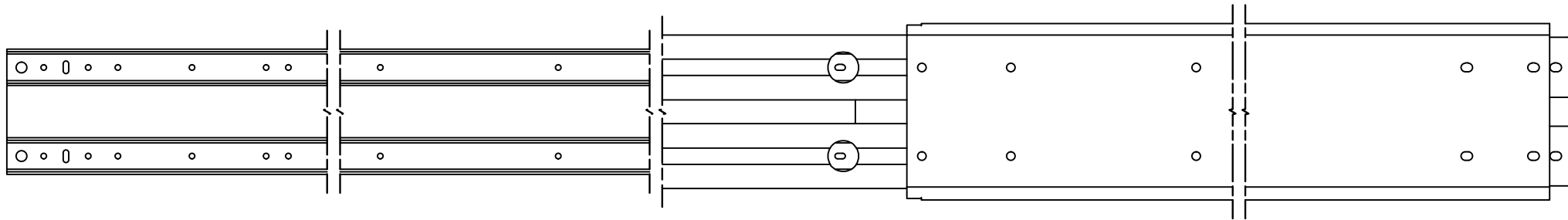

Guide per cassetti; guide telescopiche	Coulisses à billes; coulisse télescopique	REVISION HISTORY		
Drawer slide; telescopic ball bearing slide	Guías para cajones; guía teleópica	REV	DESCRIPTION	DATE
Kugelführung; Teleskopschienen		1a		06/03/2017

DESIGNED BY F.Dino	CHECKED AND APPROVED BY L. Paleari	GENERAL TOLLERANCE SS-ISO-2768-1M	DATE 06/03/2017	CODE 881400
			PACKAGING	UNIT mm
			DESCRIPTION	MATERIAL Cold rolled steel
			DEVICE	PAIR WEIGHT
Property of RAM Industrie. Without its written authorization the present drawing shall neither be used for construction anyway, communicated to third parties, nor reproduced.				

SHEET
2 of 3

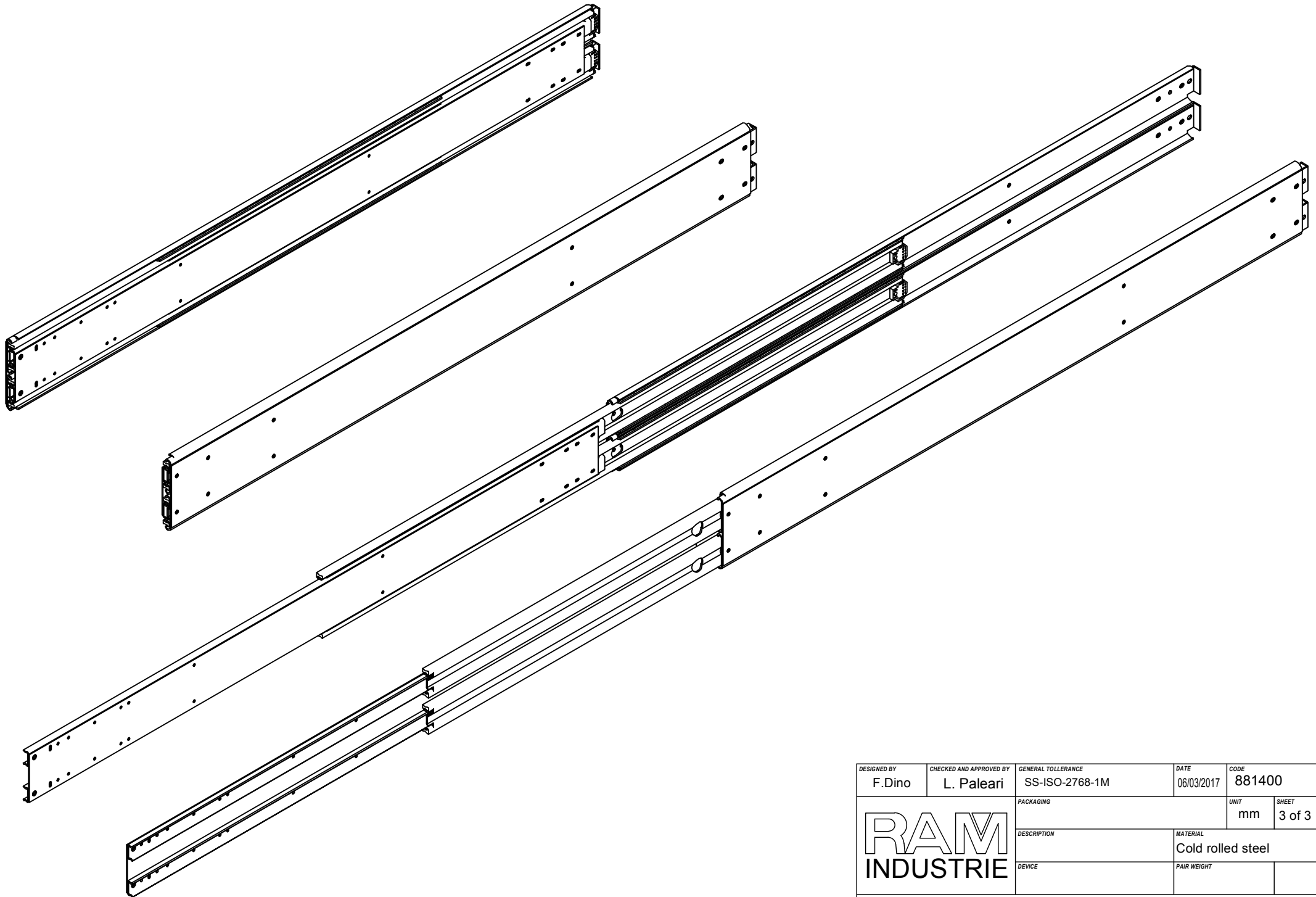

DESIGNED BY F.Dino	CHECKED AND APPROVED BY L. Paleari	GENERAL TOLERANCE SS-ISO-2768-1M	DATE 06/03/2017	CODE 881400	
			PACKAGING	UNIT mm	SHEET 3 of 3
			DESCRIPTION	MATERIAL Cold rolled steel	
DEVICE			PAIR WEIGHT		

Property of RAM Industrie.
Without its written authorization the present drawing shall neither be used for construction anyway, communicated to third parties, nor reproduced.