

SEZ. A-A

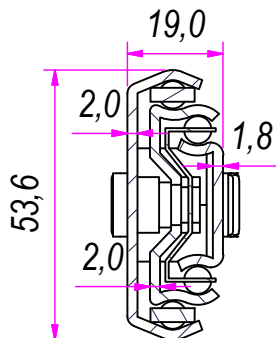

B (1 : 1.5)

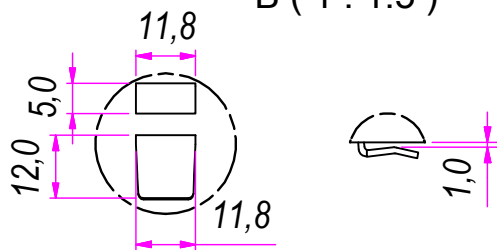

C (1 : 1.5)

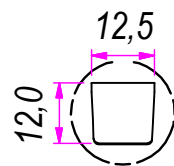

D (1 : 1)

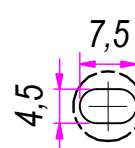

REVISION HISTORY			
REV	DESCRIPTION	APPROVED BY	DATE
1		F.Dino	15/11/2016

DESIGNED BY F.Dino	CHECKED AND APPROVED BY L. Paleari	DATE 15/11/2016	CODE 59650
		GENERAL TOLERANCE SS-ISO-2768-1M	UNIT mm
		DESCRIPTION Bayonet side mounting	MATERIAL Cold rolled steel
DEVICE		PAIR WEIGHT 3,52 Kg	SHEET 1 of 2
		02C	

Property of RAM Industrie.
Without its written authorization the present drawing shall neither be used for construction anyway, communicated to third parties, nor reproduced.

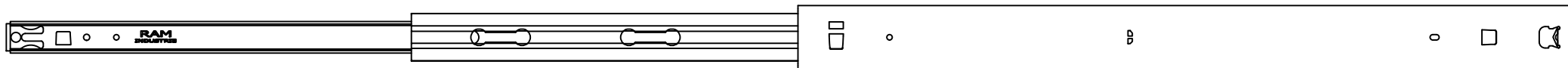

1313,0

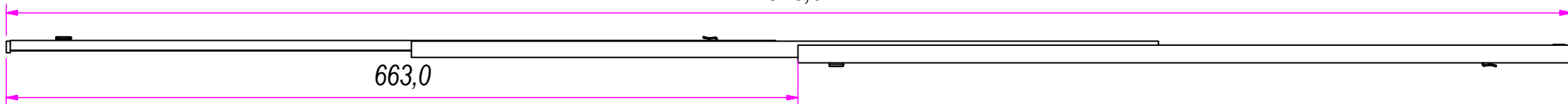

663,0

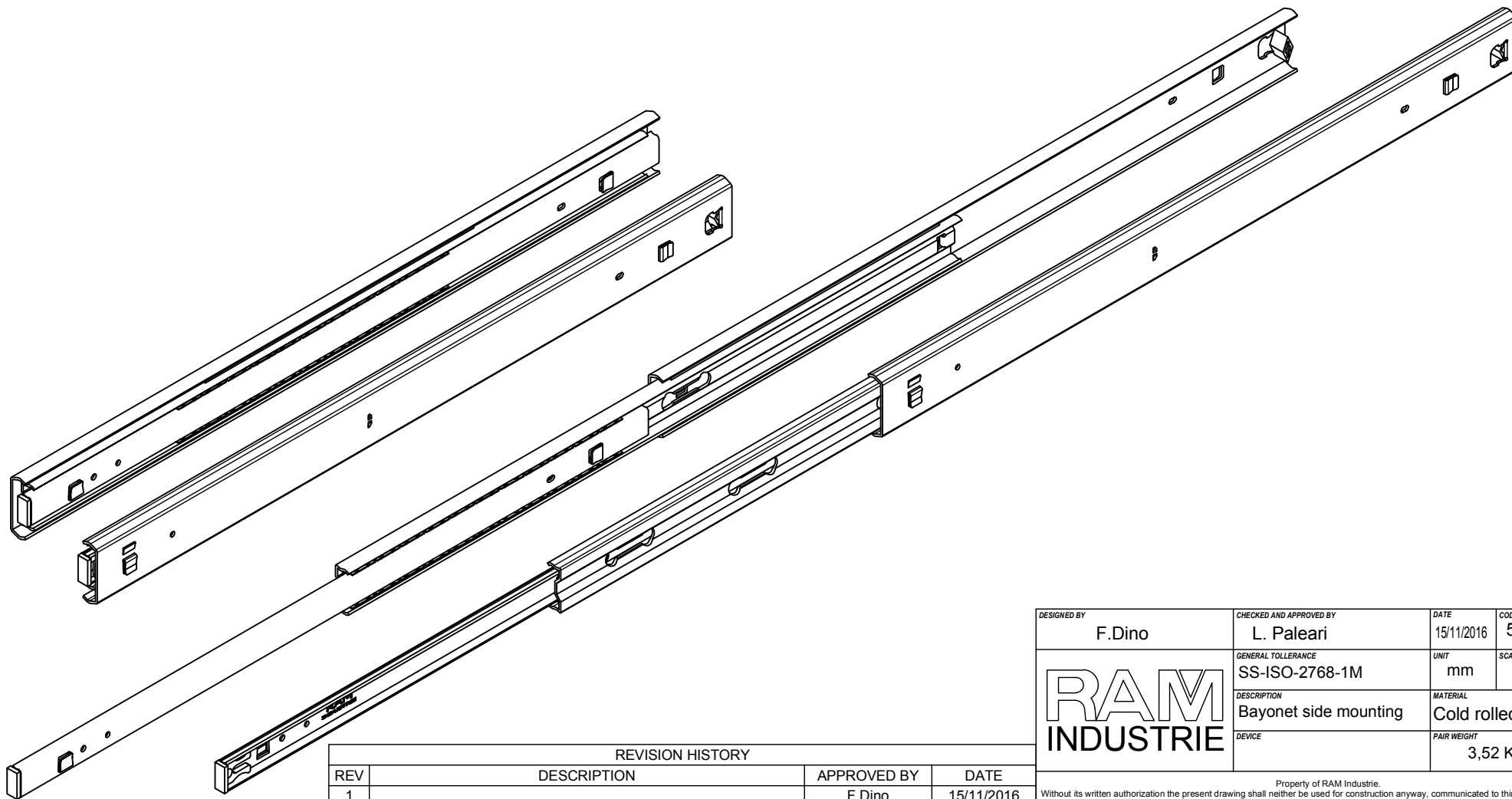
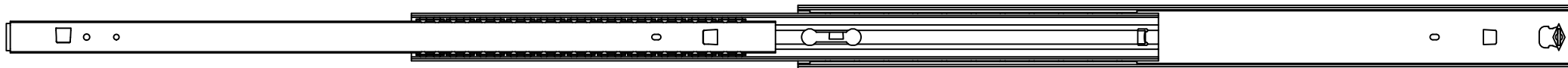

REVISION HISTORY			
REV	DESCRIPTION	APPROVED BY	DATE
1		F.Dino	15/11/2016

DESIGNED BY F.Dino	CHECKED AND APPROVED BY L. Paleari	DATE 15/11/2016	CODE 59650	
		GENERAL TOLLERANCE SS-ISO-2768-1M	UNIT mm	SCALE SHEET 2 of 2
		DESCRIPTION Bayonet side mounting	MATERIAL Cold rolled steel	PAIR WEIGHT 02C 3,52 Kg

Property of RAM Industrie.
Without its written authorization the present drawing shall neither be used for construction anyway, communicated to third parties, nor reproduced.