

DESIGNED BY F.Dino	CHECKED AND APPROVED BY L. Paleari	REVISION	DATE 20/04/2016	CODE 56350
GENERAL TOLERANCE SS-ISO-2768-1M			UNIT mm	SCALE 1 of 2
DESCRIPTION			MATERIAL Cold rolled steel	
DEVICE			PAIR WEIGHT 2,008 Kg	01T
Property of RAM Industrie. Without its written authorization the present drawing shall neither be used for construction anyway, communicated to third parties, nor reproduced.				

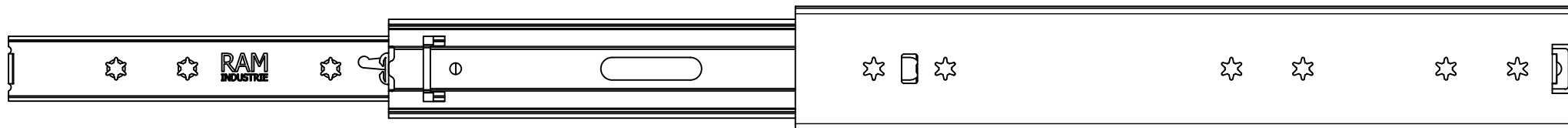

350,0

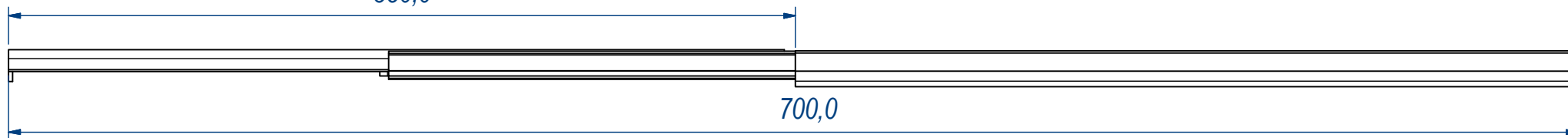

700,0

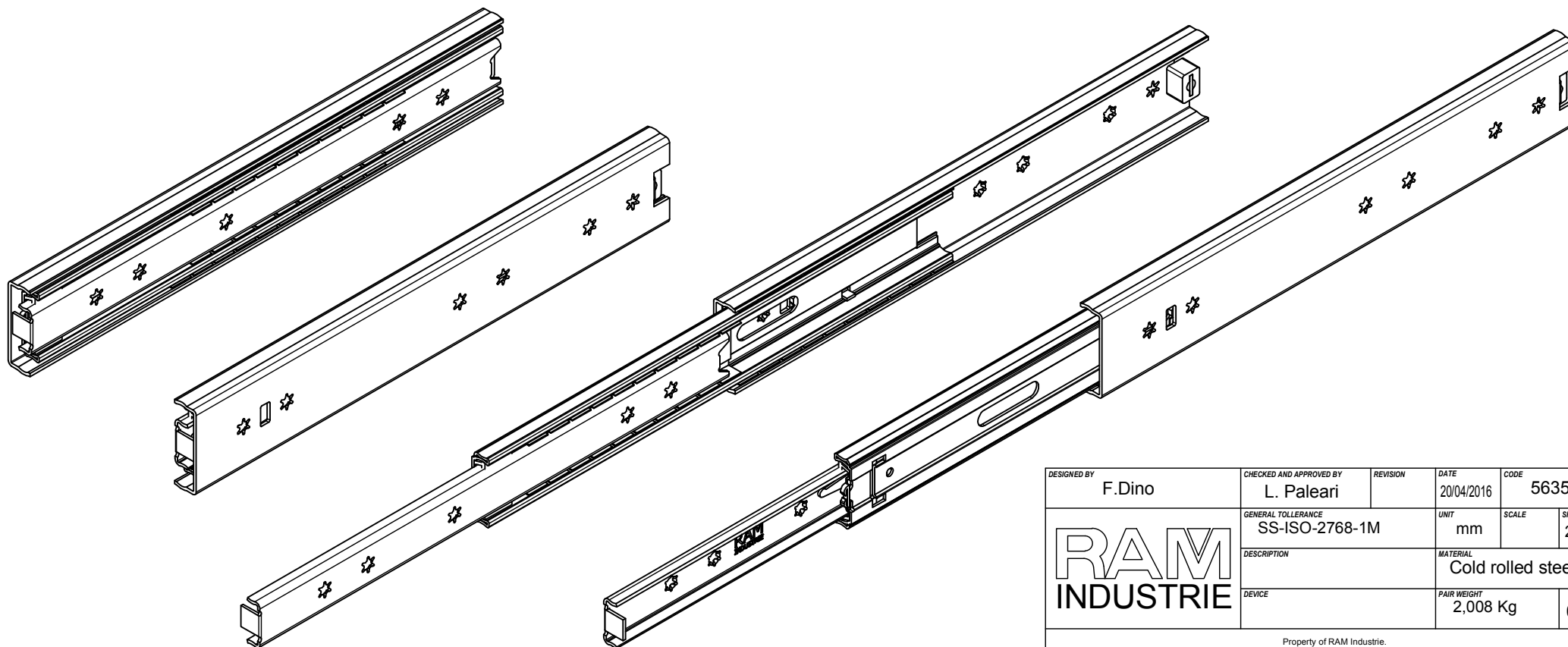
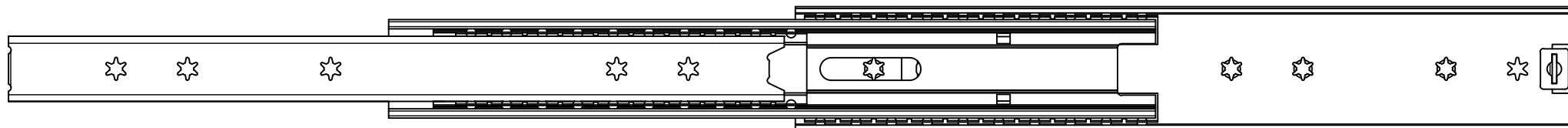

DESIGNED BY F.Dino	CHECKED AND APPROVED BY L. Paleari	REVISION	DATE 20/04/2016	CODE 56350
		GENERAL TOLLERANCE SS-ISO-2768-1M	UNIT mm	SCALE SHEET 2 of 2
		DESCRIPTION	MATERIAL Cold rolled steel	
DEVICE	PAIR WEIGHT 2,008 Kg		01T	

Property of RAM Industrie.
Without its written authorization the present drawing shall neither be used for construction anyway, communicated to third parties, nor reproduced.