

SEZ. A-A

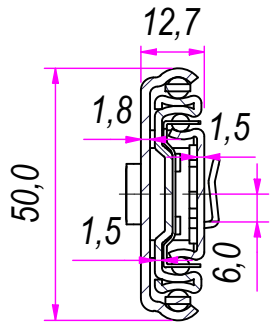

B (1:1)

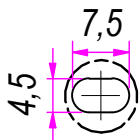

C (1:1.5)

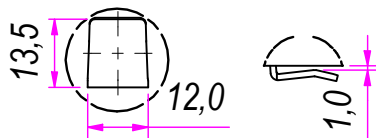

REVISION HISTORY			
REV	DESCRIPTION	APPROVED BY	DATE
1		F.Dino	11/11/2016

DESIGNED BY F.Dino	CHECKED AND APPROVED BY L. Paleari	REVISION	DATE 11/11/2016	CODE 52550
GENERAL TOLLERANCE SS-ISO-2768-1M			UNIT mm	SCALE 1 of 2
DESCRIPTION Bayonet side mounting			MATERIAL Cold rolled steel	
DEVICE			PAIR WEIGHT 2,312 Kg	02C

RAM
INDUSTRIE

Property of RAM Industrie.

Without its written authorization the present drawing shall neither be used for construction anyway, communicated to third parties, nor reproduced.

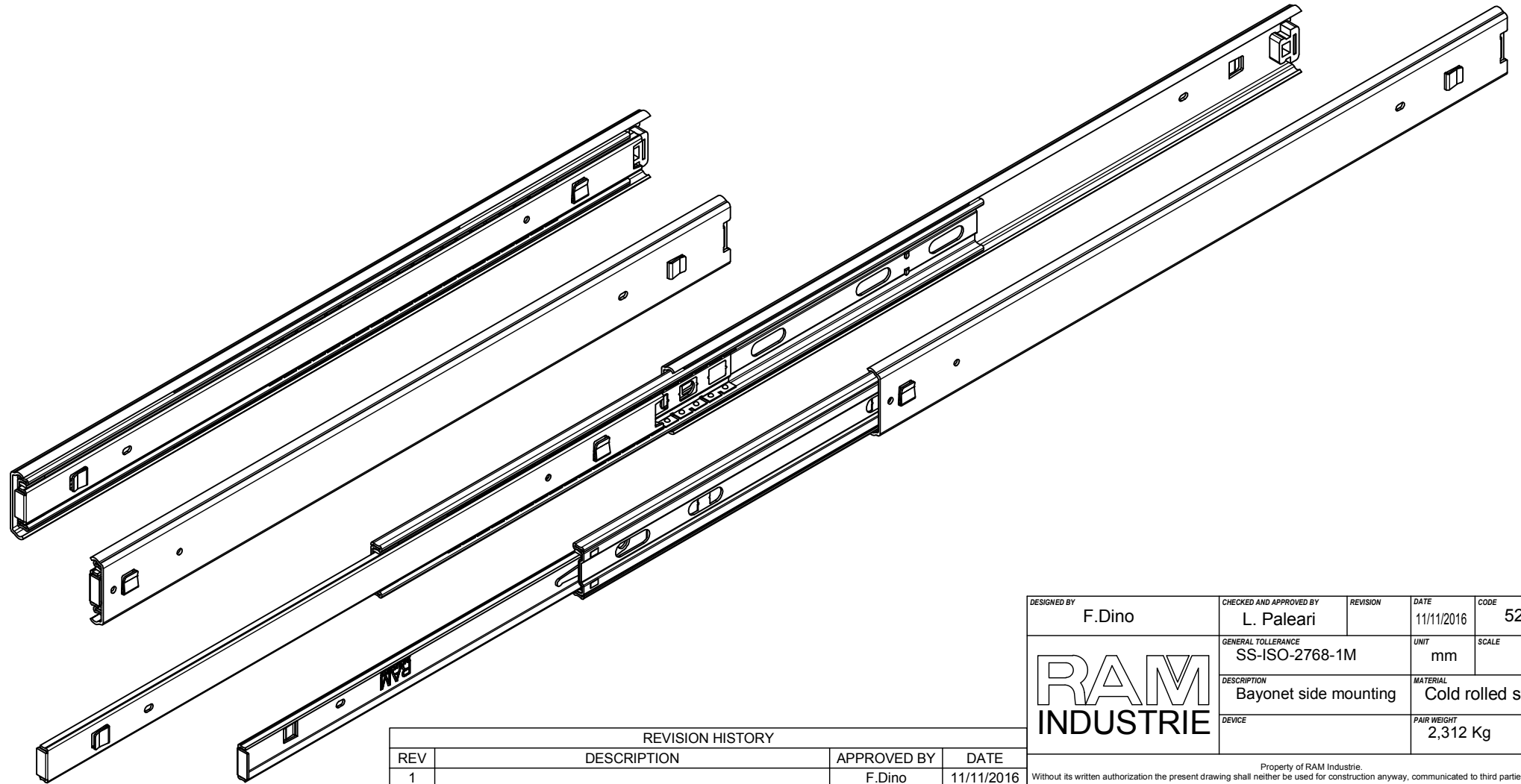
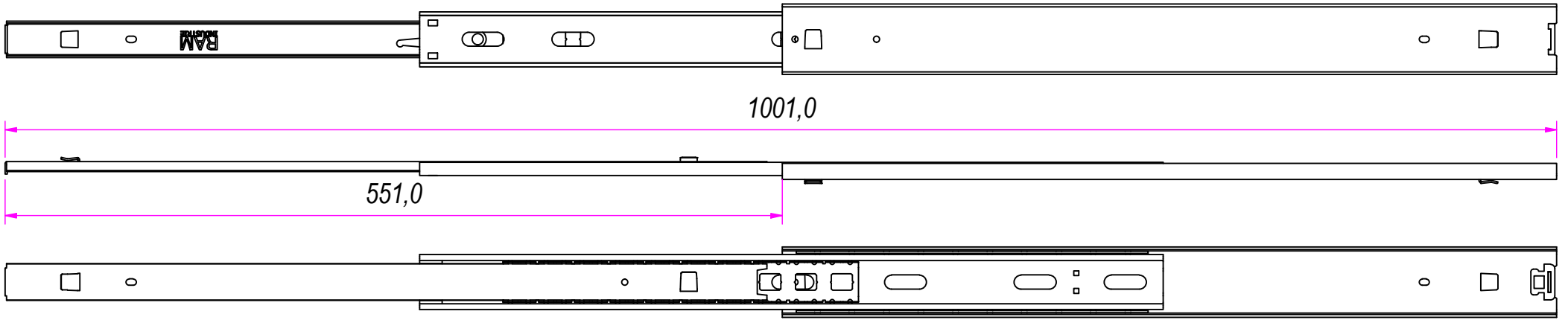

REVISION HISTORY			
REV	DESCRIPTION	APPROVED BY	DATE
1		F.Dino	11/11/2016

DESIGNED BY F.Dino	CHECKED AND APPROVED BY L. Paleari	REVISION	DATE 11/11/2016	CODE 52550
		GENERAL TOLLERANCE SS-ISO-2768-1M	UNIT mm	SCALE SHEET 2 of 2
		DESCRIPTION Bayonet side mounting	MATERIAL Cold rolled steel	PAIR WEIGHT 2,312 Kg

Property of RAM Industrie.
Without its written authorization the present drawing shall neither be used for construction anyway, communicated to third parties, nor reproduced.